



# SLICE PRO/SLICE PRO LAB SIM User's Manual



September 2022

# Table of Contents

- DTS Support ..... 4**
- Introducing the SLICE PRO SIM..... 5**
- Sensor Interface ..... 5**
  - Supported Sensor Types ..... 6
  - Input Range ..... 6
  - Excitation Sources ..... 6
  - Bridge Completion ..... 6
  - Hardware Filters..... 7
  - Offset Compensation ..... 7
  - Electronic Identification (EID)..... 7
  - Shunt Emulation..... 7
- Sampling Rates ..... 8**
- Data Memory Size..... 8**
- UP/DOWN (Bus) Interface Connectors ..... 8**
- LEDs ..... 9**
- Basic Care and Handling ..... 11**
  - Shock Rating..... 11
    - Mounting Considerations ..... 11*
  - Thermal Considerations ..... 11
- Power Management..... 13**
  - Power Consumption..... 13
  - Internal Battery..... 13
  - Power-up and Power-down Procedures ..... 14
- Communication Features ..... 15**
- Data Collection Concepts..... 16**
  - Data Collection Modes ..... 16
    - Circular Buffer Mode..... 16*
    - Recorder Mode..... 16*
    - Hybrid Recorder Mode..... 16*
    - Continuous Recorder Mode..... 16*

Start Record and Event Initiation ..... 17

**Appendix A: SLICE PRO SIM Sensor Connector Pin Assignments..... 18**

**Appendix B: UP/DOWN Connector Information ..... 27**

**Appendix C: Mechanical Specifications..... 29**

    Accessories/Support Equipment..... 31

**Appendix D: How to Calculate Data Storage Duration..... 32**

    Circular Buffer Limitations ..... 32

**Appendix E: Declaration of CE Conformity ..... 33**

## DTS Support

SLICE PRO systems are designed to be reliable and simple to operate. Should you need assistance, DTS has support engineers worldwide with extensive product knowledge and crash test experience to help via telephone, e-mail or on-site visits.

The best way to contact a DTS support engineer is to submit a request through the DTS Help Center ([support.dtsweb.com](https://support.dtsweb.com)). You must be registered ([support.dtsweb.com/registration](https://support.dtsweb.com/registration)) to submit a request (<https://support.dtsweb.com/hc/en-us/requests/new>). Registration also enables access to additional self-help resources and non-public support information.

This manual supports the SLICE PRO/SLICE PRO LAB SIM that uses the part number format 13**XXX**-7**XXPP** where:

- **X** = form factor (**0** for crashworthy –or– **1** for stationary)
- **XX** = number of channels (**09** –or– **18**)
- **X** = bandwidth (**A** = automotive –or– **H** = high bandwidth –or– **M** = maximum)
- **X** = 1/4 bridge (**1** = 120 ohm –or– **3** = 350 ohm)
- **PP** = sensor connector termination option (see Appendix A)

For example, part number 13018-7A339 is specified as:

- Crashworthy
- 18 channels
- Automotive bandwidth
- 350 ohm 1/4 bridge
- Option 39 pin assignments

Please see your packing list for the part number of your unit.

# Introducing the SLICE PRO SIM

The SLICE PRO Sensor Input Module (SIM) is a high-speed, high-performance, industrial data acquisition system. The system is configurable and is supplied with either 9- or 18-channels. The SLICE PRO SIM supports many sensor types and sensitivities, interfacing with common and not-so-common sensors.

- Sample rates up to 1 Msps on 9 channels simultaneously.
- Shock hardened to 100 g for dynamic testing environments (crashworthy version only).
- 9 or 18 sensor input channels support conventional bridge sensors or IEPE sensors, each with isolated excitation, high impedance differential input amplifier, and automatic sensor identification circuits.
- Internal battery with up to 1 hour capacity functions as primary or back-up power (crashworthy version only).
- LED indicators for power and system status.
- Easy communications via the SLICE PRO Ethernet Controller or SLICE PRO USB Controller. (SLICE PRO LAB available with Ethernet Controller only.)
- Chainable with up to 3 other SLICE PRO modules.

Connector information and pin assignments can be found in Appendices A and B. Mechanical specifications are included in Appendix C. Appendix D provides information on how to calculate data storage duration. Please see the label on your unit for hardware specifications or your packing list for the part number of your hardware; part number specifications can be found on page 4.

## Sensor Interface

The SLICE PRO SIM is available with LEMO 1B, 2B or Tajimi 7-pin sensor input connectors. See Appendix A for sensor connector pin assignments.



## Supported Sensor Types

The SLICE PRO SIM supplies 2, 5, 7.5 and 10 V excitation up to 40 mA and supports many types of sensors including accelerometers, load cells and pressure sensors. The following general sensor types are supported:

- Full-bridge (4-wire), half-bridge (3-wire), quarter-bridge (e.g., 2- or 3-wire strain gage), resistive and piezo-resistive types.
- Voltage input range:  $\pm 2.5$  V; up to 800 V with available range expander cable.
- Conditioned sensors with 2.5 V centered signal output.
- IEPE sensors, including accelerometers, microphones and many others.

Sensor connection diagrams are available on the [DTS Help Center](#). If you have additional questions regarding what sensors are supported, please contact DTS and provide the sensor manufacturer and model number, if available.

## Input Range

The nominal sensor input range is  $\pm 2.5$  V at a gain of 1. At higher gains, the maximum range decreases correspondingly. For example, at a gain of 10, the input range is  $\pm 240$  mV. (The software will automatically calculate the gain based on the user-specified input range and other sensor parameters.)

The nominal input range for an IEPE sensor is 0-24 V ( $\pm 12$  V) at unity gain. As with bridges, at higher gains, the input range decreases accordingly. For example, when the SLICE PRO SIM applies a gain of 4, the input range will be 4 times smaller, or  $\pm 3$  V.

## Excitation Sources

The excitation source for each channel is individually controlled and isolated. Excitation sources are not turned on until the software initializes the system during diagnostics. The bridge excitation can be set at 2.0, 5.0, 7.5, 10.0 V or off.

Units manufactured in late 2021/early 2022 support 10.0 mA constant current, IEPE excitation. Older units support 4.0 mA. Contact DTS if you need help determining the IEPE excitation your equipment supports.

## Bridge Completion

Half-bridge and 3/4-bridge completion for any channel may be selected via software. Half-bridge transducers should be connected to  $\pm Ex$  and  $-Sig$ . The value of half-bridge completion resistors is 3,000 ohms ( $\pm 0.1\%$ ).

Quarter-bridge transducers should be connected to  $+Ex$  and  $-Sig$ . There are 2 options available: 350 ohm ( $\pm 0.1\%$ ) or 120 ohm ( $\pm 0.1\%$ ). Please see your packing list for your hardware's specifications.

## Hardware Filters

There are 3 hardware filter combinations available. Each option includes:

- A fixed, 8-pole Butterworth anti-aliasing filter with one fixed -3 dB knee point, and
- A software-controlled, variable 5-pole Butterworth filter.

Bandwidth Option	8-pole Filter (fixed)	5-pole Filter (adjustable up to 45 kHz)
Automotive (standard)	4 kHz (for rates $\geq 20$ ksps)	for rates $< 20$ ksps
High <sup>1</sup>	100 kHz (for rates of 500 ksps or 1 Msps)	for rates $< 500$ ksps
Maximum <sup>1</sup>	200 kHz (for 1 Msps)	for rates $< 1$ Msps

The 5-pole filter is used together with the 8-pole filter at lower sampling rates. The software will automatically choose the best filter setting for a given sampling rate. The relationship between sampling rate and anti-alias filter frequency is defined in the software configuration files. Please see the software manual for additional information.

## Offset Compensation

Each channel can compensate for a sensor offset of up to 200% of the full-range output of a sensor. The sensor offset is measured and the hardware compensation is adjusted during the diagnostic check. Please see the software manual for additional information.

## Electronic Identification (EID)

Each measurement channel supports communication with silicon serial number devices manufactured by Dallas Semiconductor/Maxim Integrated Products for both bridge and IEPE sensors. When an ID chip is connected to the proper pins on the sensor connector, the software can automatically read these devices and correlate the serial number to channel set-up information stored in the sensor database. (Note that sensor ID for IEPE is typically integrated into the sensor using the existing 2-wire interface and do not require a separate pin.)

## Shunt Emulation

SLICE PRO SIM channels contain a shunt emulation circuit, effectively eliminating the need for conventional shunt resistors to perform shunt checks. When "Emulation" is chosen as the shunt calibration method, the software injects a precisely-calculated current into the sensor to create an expected deflection of the sensor's output. Settings are automatically calculated by the software to simulate 70-80% of the full-scale of the analog-to-digital converter. Please see the software manual for additional information.

<sup>1</sup> Note: The firmware will use the maximum filter the switch cap will allow when a sampling rate is chosen that results in a 1/5 filter setting that is less than the hardware filters.

## Sampling Rates

The SLICE PRO SIM has user-selectable sampling rates from 100 sps to 1 Msps. The maximum sampling rate for 9 channels is 1 Msps; the maximum sampling rate for 18 channels is 500 ksp. Only 9 channels (channels 1-9 specifically) are available for any sampling rate >500 ksp. For information on how to calculate data storage duration, please see Appendix D.

## Data Memory Size

With 15 GB of flash memory available for data storage, the SLICE PRO SIM can record ~14 minutes of data at the maximum sampling rate (9 channels at 1 Msps or 18 channels at 500 ksp). Since the recording capacity is very large, it is generally best to limit sampling rates and event durations to the minimum necessary to avoid large and cumbersome data files. Large files take longer to download and may also be time-consuming to post-process or difficult to share. Use of the Region of Interest (ROI) download can save a great deal of time if implemented properly. For information on how to calculate data storage duration, please see Appendix D.

## UP/DOWN (Bus) Interface Connectors



SLICE PRO

The UP interface connector allows the user to interface to a SLICE PRO Ethernet Controller, USB Controller or another SLICE PRO module. (The UP connector may appear loose, however do not tighten.) The DOWN interface connector allows the user to interface to another SLICE PRO module (chainable with up to 3 other modules). The SLICE PRO LAB SIM uses a single 25-pin bus connector for the same functions and interfaces directly to the SLICE PRO LAB rack. Please see Appendix B for pin assignments.

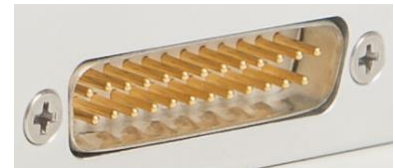

SLICE PRO LAB



## LEDs

There are 2 LED indicators. The STS LED indicates communication and arm status and the PWR LED indicates power status. At system power-up, the red-green-blue LED initialization sequence is performed by the STS LED followed by the PWR LED.











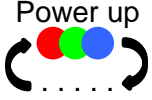

LED behavior is summarized below.

Condition	
<b>Charging (system off and connected to external power)<sup>2</sup></b>	
Unit is charging (power OK) <sup>1</sup>	●
Unit fully charged <sup>1</sup>	●
<b>System on; not armed</b>	
Power up	●●●●
Power OK; no USB	●
Communicating with host	●
<b>System on; armed</b>	
Armed and waiting for Start Record signal to begin data collection (Recorder Mode only)	●
Start Record signal received and recording data (Recorder Mode) –or– armed and recording data (Circular Buffer Mode); waiting for Event signal <sup>3</sup>	●
Event signal received <sup>2</sup> –or– fault	●
Event signal received + data collection completed (no USB)	●
Fault received + data collection completed (no USB)	●
Data collection completed; PC downloading data	●







<sup>2</sup> SLICE PRO LAB systems do not contain internal batteries and must be connected to external power at all times.

<sup>3</sup> Event signal optional in Recorder Mode.

**Firmware version A1R4 or higher**

Battery Charge Status <sup>4</sup>				
		OFF	ON	
		Charging (0.4 Hz)	Discharging (1 Hz)	
>90%				
50% - <90%				
20% - <50%				
<20% or FAULT				

**Firmware version A1Q1 or lower**

Condition	
<b>Charging (system off and connected to external power)<sup>3</sup></b>	
Unit is charging (power OK) <sup>3</sup>	
Unit fully charged <sup>3</sup>	
<b>System on</b>	
Power up	
Power OK; no USB	
Power OK; USB connected	
Power fault (out of range)	

<sup>4</sup> SLICE PRO LAB systems do not contain internal batteries and must be connected to external power at all times.

## Basic Care and Handling

SLICE PRO systems are precision devices designed to operate reliably in dynamic testing environments. Though resistant to many environmental conditions, care should be taken not to subject the unit to harsh chemicals, submerge it in water, or drop it onto any hard surface.

### **WARNING:**

**Electronic equipment dropped from desk height onto a solid floor may experience up to 10,000 g. Under these conditions, damage to the exterior and/or interior of the unit is likely.**

The SLICE PRO SIM is supplied with calibration data from the factory. DTS recommends annual recalibration to ensure that the unit is performing within factory specifications. The SLICE PRO SIM is not user-serviceable and should be returned to the factory for service or repair.

When not in use or if shipping is required, we suggest that you always place the unit in the padded carrying case originally provided with your unit.

### **Shock Rating**

The SLICE PRO SIM is rated for 100 g, 12 ms half-sine duration, in all axes.

SLICE PRO LAB equipment is not crashworthy and should not be exposed to shock, vibration or other extreme environmental conditions.

### ***Mounting Considerations***

Crashworthy SLICE PRO equipment should be bolted securely to the test vehicle or dynamic testing device to provide the best shock protection. Mounting methods and hardware selection should be carefully calculated to withstand expected shock loading and facilitate proper grounding. Check bolt tightness periodically to ensure that 1) the unit is securely fastened to the baseplate, and 2) the baseplate is securely fastened to the testing platform. (See Appendix C for the unit's mechanical specifications.)

DTS strongly recommends that all equipment be properly grounded to minimize any risk of data noise due to high-current transients. The test vehicle or dynamic testing device should be connected to earth ground. Crashworthy SLICE PRO equipment should be grounded to each other and bolted to the test vehicle. SLICE PRO LAB modules should be bolted to the rack and the rack properly grounded. DTS recommends checking continuity between the enclosures of each unit to confirm resistance readings of <1 ohm.

### **Thermal Considerations**

SLICE PRO systems are low power devices with negligible self-heating and it is unlikely that self-heating will be an issue in real-world testing. Should you have any questions about using SLICE PRO in your environment, please contact DTS.

**WARNING:**

Due to battery chemistry, do not operate SLICE PRO DAS at temperatures below 0°C (32°F) or in excess of 60°C (140°F).

## Power Management

A good power source is of paramount importance. SLICE PRO SIMs should be powered from a SLICE PRO Controller. (One Controller can support up to 4 SLICE PRO modules.) Be sure to consider any power drop due to cable length.

Input Voltage, System OFF/ON	Power Consumption, System OFF*	Power Consumption, System ON**
11.5-15 VDC; 15 VDC nominal	7.5 W; 500 mA per module***	15 W; 1 A per module***

\* charging all internal batteries

\*\* fully armed + charging all internal batteries

\*\*\* Controllers are considered modules for the purposes of power calculations.

SLICE PRO LAB systems do not contain internal batteries and must be connected to external power at all times (15 VDC nominal; 9-15 V range at 40 W via the SLICE PRO LAB Ethernet rack).

### Power Consumption

**Power off:** When connected to sufficient external power, the SLICE PRO SIM will draw up to 500 mA for charging the internal battery.

**Power on:** When the SIM is initially powered, all sensor excitation sources, calibration circuitry, signal conditioning sources, adjustable filter circuits are in a shutdown state. When the user runs a test set-up, the software automatically energizes these circuits. The current draw per module will increase from ~625 mA to as much as 1 A when the system is fully armed and powering 350 ohm bridges with 5 V excitation.

**During data collection:** Once the system has been armed for data collection, all circuits remain in a full power state until data collection is finished. After the data collection routine has completed, the system de-energizes several circuits to minimize power consumption.

### Internal Battery

The SLICE PRO SIM contains an internal 7.4 V (nominal) lithium battery that operates as primary power or back-up power should primary power fail. When fully charged, battery capacity is sufficient to provide primary power and sustain full operation for 1 hour with 5 V excitation (40 minutes with 10 V excitation). It charges whenever sufficient external power is connected to the module via a SLICE PRO Controller. The maximum charge time is 3-4 hours from complete discharge to full capacity. The module does not need to be ON in order to charge the internal battery.

Charging practices can affect the useful operational life of the battery. In addition to good charging habits, conditioning the battery may be useful—3 deep-discharge/recharge cycles may help increase battery performance. The battery's useful capacity is greatly shortened near the end of its service life and should be replaced when it has decreased to 50% of its initial capacity. The battery is not user-serviceable and should be returned to the factory for battery replacement.

**WARNING:**

**Due to battery chemistry, do not operate SLICE PRO DAS at temperatures below 0°C (32°F) or in excess of 60°C (140°F).**

SLICE PRO LAB systems do not contain internal batteries and must be connected to external power at all times (15 VDC nominal; 9-15 V range at 40 W via the SLICE PRO LAB Ethernet rack).

**Power-up and Power-down Procedures**

The SLICE PRO SIM is powered up when the proper signal is connected at the UP interface connector. This is typically accomplished via a SLICE PRO Controller. Power-up of the module takes 10 seconds (USB Controller) or between 1-2 minutes (Ethernet Controller), after which communication is enabled.

To restart a system, turn off the Controller and wait ~30 seconds before reinitializing. (Press and hold the switch firmly for 2 seconds to start or stop the system.) If a system is armed for data collection, it will remain on until it is disarmed or power reserves are exhausted. An incomplete power-down/power-up cycle can result in errors, so be certain to follow proper procedures.

**CAUTION:**

**Do not turn off the Controller if the system is armed. You must disarm the system before initiating a system restart.**

## Communication Features

Communications with the SLICE PRO SIM is accomplished via 1) a SLICE PRO USB Controller and USB comm cable (USB A to USB B) or 2) a SLICE PRO Ethernet Controller and Ethernet (REC) comm cable (P/N 10700-0015x). Please see the [SLICE PRO USB Controller](#) or [SLICE PRO Ethernet Controller](#) User's Manuals for additional information.

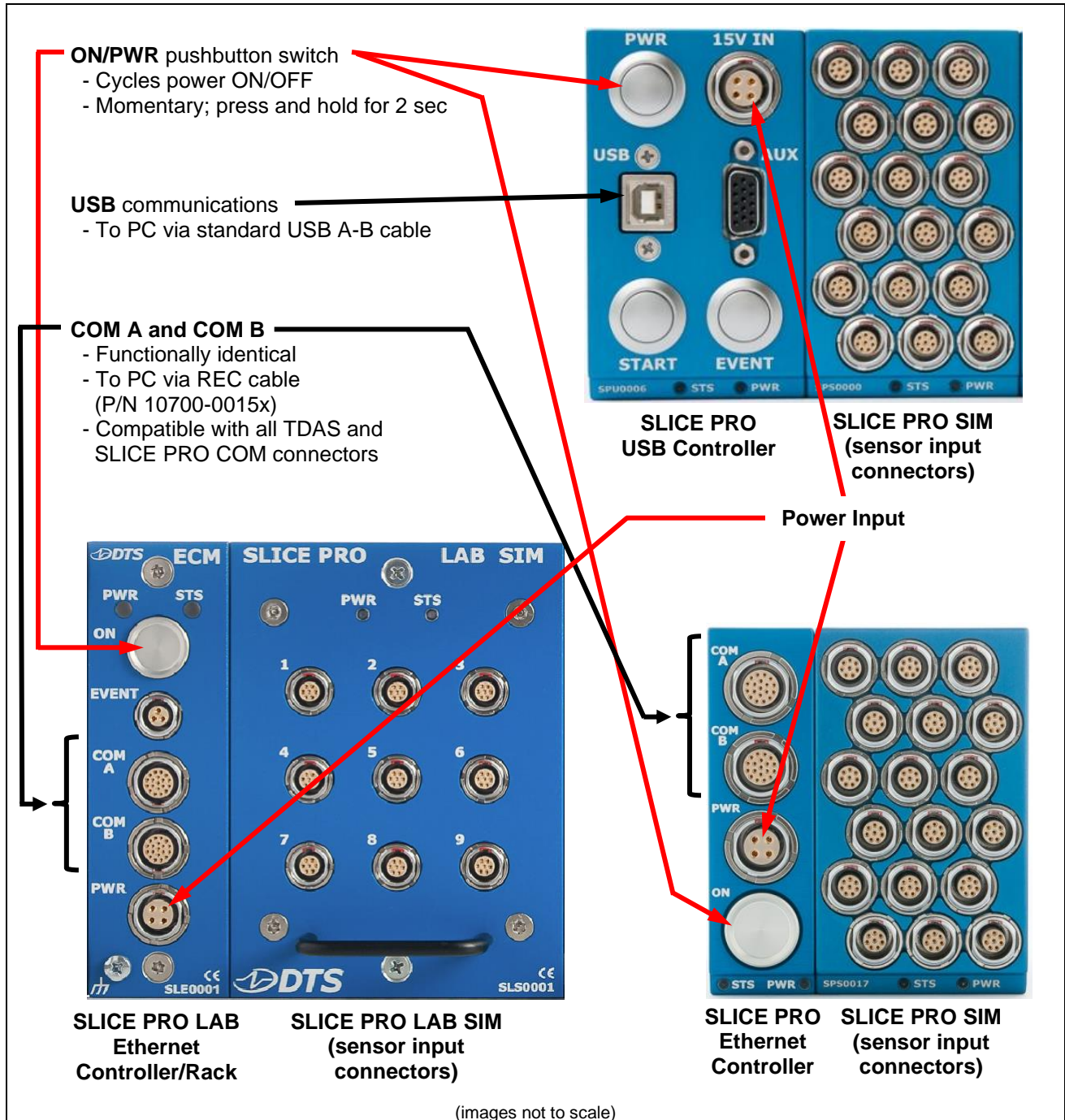

**SLICE PRO/SLICE PRO LAB System Set-up**

## Data Collection Concepts

The discussion below provides a general introduction to data collection. Please see the software manual for a detailed discussion and implementation specifics.

SLICE is a standalone data logger. Once the system is armed, the PC can be disconnected if desired. After receiving a Start Record or Event signal, SLICE autonomously collects data, storing it to flash memory with no user interaction. After the test, the user reconnects the PC to download the data.

There is also a real-time mode in the control software that allows the user to check channel inputs on an oscilloscope-looking screen. (This data can be logged.)

### Data Collection Modes

SLICE supports 4 data collection modes: Circular Buffer, Recorder, Hybrid Recorder, and Continuous Recorder. (Note: The software cannot simultaneously display the data while the system is recording.)

#### ***Circular Buffer Mode***

Using Circular Buffer mode, the user can program SLICE to record pre- and post-Event data. Time Zero (T=0) is marked when the Event signal is received.

Due to the nature of flash memory, the system cannot be armed in Circular Buffer mode indefinitely. Please see Appendix D for information on how to calculate data storage duration when using Circular Buffer mode.

#### ***Recorder Mode***

Data collection begins when a Start Record signal is received and continues for the time specified in the test set-up. If an Event signal is received sometime after the Start Record, this is marked as T=0.

#### ***Hybrid Recorder Mode***

Data collection begins when a Start Record signal is received and continues until the unit receives an Event signal. The unit then records for the post-Event time specified by the user. The Event signal marks the T=0 point and all data recorded is available for download.

#### ***Continuous Recorder Mode***

Data collection begins when a Start Record signal is received and continues until the Start Record signal is released. The unit will then re-arm for another event. The unit will continue to record new events until it records the number of events specified by the user. If an Event signal is received after the unit has re-armed, the unit will disarm and no longer attempt to re-arm.



## Start Record and Event Initiation

The SLICE PRO SIM supports multiple methods of initiating Start Record and Event signals. Typically, Start Record and Event are initiated via an external hardware interface that provides a discrete contact closure (CC) signal to initiate recording (Recorder mode) or mark T=0 (Circular Buffer mode).

All SLICE data collection modes have a multi-event arming mode. A unit armed in a multiple-event mode will re-arm when an event completes. The unit will stop re-arming when the number of events specified by the user has been recorded.

SLICE can be placed in an auto-arm mode that will cause the unit to arm automatically when the power is cycled. This available with any data collection mode.

Additionally, Circular Buffer mode supports level triggering. This method continuously samples the incoming data and begins data collection if the data is above or below predefined levels. For example, it might be useful to begin data collection when a certain accelerometer experiences a force above 200 g. Using level trigger, and Circular Buffer mode, the SLICE PRO SIM can support this or any level-trigger signal on any channel.

Finally, if the SLICE PRO SIM remains connected to the PC during data collection, the control software can be used to begin data collection.

The table below summarizes the data collection modes and event/triggering options.

	<b>Supports T=0 Start Record</b>	<b>T=0 methods supported</b>	<b>Data record window</b>
<b>Circular Buffer</b>	Yes	Hardware (CC), software (PC) or level trigger	User-defined pre- and post- T=0 durations
<b>Recorder</b>	Yes	Hardware (CC), software (PC) or level trigger	User-defined duration after T=0
<b>Hybrid Recorder</b>	Yes	Hardware (CC), software (PC) or level trigger	User-defined post-Event duration
<b>Continuous Recorder</b>	Yes	Hardware (CC), software (PC), or level trigger	User-defined duration after T=0, with recording multiple events possible

## Appendix A: SLICE PRO SIM Sensor Connector Pin Assignments

A variety of connector options and sensor pin assignments are available. It is unlikely that you can determine what option you have by visual inspection as a connector may have more than one pin assignment option. If you need information on the specifics of your equipment, please submit a request through the DTS Help Center web portal ([support.dtsweb.com](http://support.dtsweb.com)) and provide the serial number(s) of the equipment and parameters you are asking about.

Some pin assignments permit multiple termination options for a signal, however you should only connect to one termination point. Do not connect any one signal to more than one location.

(Pin assignments are identified in the last 2 characters of the part number for your unit (e.g., 13018-7A339 = pin assignment option 39). Please see your packing list for this information.)

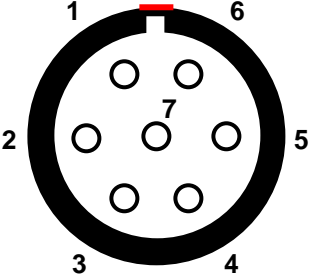
SLICE PRO SIM							
EEG.1B.307.CLL							
 <p style="text-align: center;">(panel view)</p> <p style="text-align: center;">(Suggested cable connector P/N: FGG.1B.307.CLAD42*)</p>							
<b>Pin assignments: Option 02**</b>							
1	2	3	4	5	6	7	Case
N/C	+ID	+Sig	+Ex	-Ex	-Sig	N/C	-ID/Shield

\* A 6-pin connector (i.e., FGG.1B.306.CLAD42) may also be used.

\*\* Compatible with legacy TDAS sensor option A. IEPE is not supported with this option.

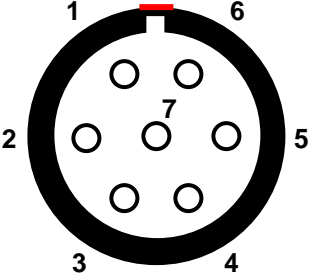
<b>SLICE PRO SIM</b>							
EEG.1B.307.CLL  (panel view) (Suggested cable connector P/N: FGG.1B.307.CLAD42*)							
<b>Pin assignments: Option 04**</b>							
1	2	3	4	5	6	7	Case
+Ex	-Ex	+Sig	-Sig	-ID/Shield	+ID	N/C	Shield

\* A 6-pin connector (i.e., FGG.1B.306.CLAD42) may also be used.

\*\* Compatible with legacy TDAS sensor option E. IEPE is not supported with this option.

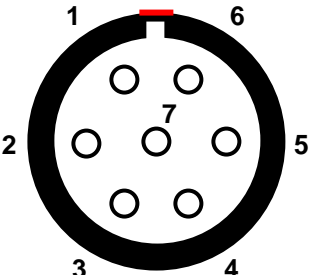
<b>SLICE PRO SIM</b>							
EEG.1B.307.CLL  (panel view) (Suggested cable connector P/N: FGG.1B.307.CLAD42*)							
<b>Pin assignments: Option 09**</b>							
1	2	3	4	5	6	7	Case
-ID/Shield	+ID	+Sig	+Ex	-Ex	-Sig	N/C	-ID/Shield

\* A 6-pin connector (i.e., FGG.1B.306.CLAD42) may also be used.

\*\* Compatible with legacy TDAS sensor option H. IEPE is not supported with this option.

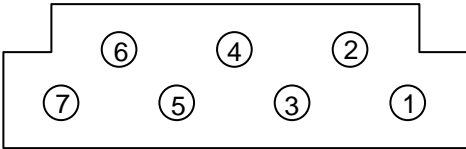
<b>SLICE PRO SIM</b>						
<p>3RT01-RW7F</p>  <p>(panel view)</p> <p>(Suggested cable connector P/N: 3RT01-PE7M)</p>						
<b>Pin assignments: Option 21*</b>						
1	2	3	4	5	6	7
+Ex	Shield	+Sig	-ID	-Ex	+ID	-Sig

\* IEPE is not supported with this option.

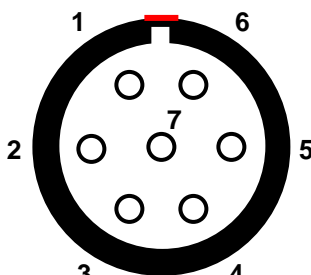
<b>SLICE PRO SIM</b>							
<p>EEG.0B.307.CLL</p>  <p>(panel view)</p> <p>(Suggested cable connector P/N: FGG.0B.307.CLAD42)</p>							
<b>Pin assignments: Option 25*</b>							
1	2	3	4	5	6	7	Case
-ID/Shield	+Ex	+Sig	-Sig	-Ex	N/C	+ID	Shield

\* IEPE is not supported with this option.

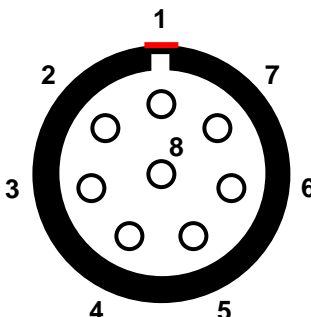
<b>SLICE PRO SIM</b>								
EEG.1B.308.CLL  (panel view) (Suggested cable connector P/N: FGG.1B.308.CLAD42)								
<b>Pin assignments: Option 39*</b>								
1	2	3	4	5	6	7	8	Case
-Ex	+Ex	-Sig	+Sig	-IEPE	+IEPE	-ID	+ID	Shield

\* Compatible with legacy TDAS DTS standard sensors (option 01).

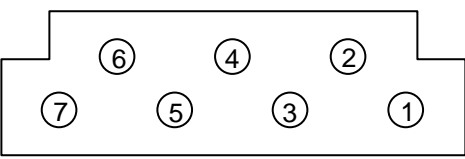
<b>SLICE PRO SIM</b>						
3RT01-RW7F  (panel view) (Suggested cable connector P/N: 3RT01-PE7M)						
<b>Pin assignments: Option 40</b>						
1	2	3	4	5	6	7
+Ex	-IEPE/-ID/Shield	+Sig	+IEPE	-Ex	+ID	-Sig

**SLICE PRO SIM**

EEG.1B.307.CLL

(panel view)

(Suggested cable connector P/N: FGG.1B.307.CLAD42\*)

<b>Pin assignments: Option 41**</b>							
1	2	3	4	5	6	7	Case
N/C	-Sig	+Sig	+Ex	-Ex	+ID	N/C	-ID/Shield

\* A 6-pin connector (i.e., FGG.1B.306.CLAD42) may also be used.

\*\* Compatible with legacy TDAS sensor option 41. IEPE is not supported with this option.

**SLICE PRO SIM**

EEG.1B.307.CLL

(panel view)

(Suggested cable connector P/N: FGG.1B.307.CLAD42\*)

<b>Pin assignments: Option 42**</b>							
1	2	3	4	5	6	7	Case
-IEPE/-ID	+ID	+Sig	+Ex	-Ex	-Sig	+IEPE	-ID/Shield

\* A 6-pin connector (i.e., FGG.1B.306.CLAD42) may also be used if IEPE (pin 7) is not needed.

\*\* Compatible with legacy TDAS option A sensors if external shunt resistors are not installed.

**SLICE PRO SIM**

EEG.1B.307.CLL

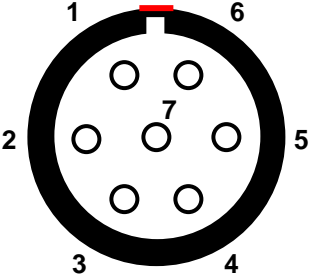

(panel view)

(Suggested cable connector P/N: FGG.1B.307.CLAD42\*)

**Pin assignments: Option 45**

1	2	3	4	5	6	7	Case
+Ex	-Ex	+Sig	-Sig	-IEPE/-ID	+ID	+IEPE	-ID/Shield

\* A 6-pin connector (i.e., FGG.1B.306.CLAD42) may also be used if IEPE (pin 7) is not needed.

**SLICE PRO SIM**

EEG.1B.307.CLL

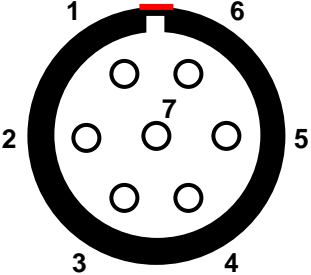

(panel view)

(Suggested cable connector P/N: FGG.1B.307.CLAD42\*)

**Pin assignments: Option 46\*\***

1	2	3	4	5	6	7	Case
+Ex	-Ex	+Sig	-Sig	-ID/Shield	+ID	-ID	Shield

\* A 6-pin connector (i.e., FGG.1B.306.CLAD42) may also be used if sensor ID (pin 7) is not needed.

\*\* IEPE is not supported with this option.

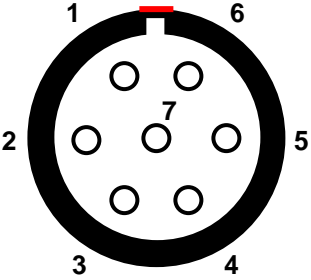
SLICE PRO SIM							
EEG.1B.307.CLL							
							
(panel view)							
(Suggested cable connector P/N: FGG.1B.307.CLAD42*)							
Pin assignments: Option 47							
1	2	3	4	5	6	7	Case
+IEPE	+ID	+Sig	+Ex	-Ex	-Sig	-IEPE/-ID	-ID/Shield

\* A 6-pin connector (i.e., FGG.1B.306.CLAD42) may also be used if IEPE (pin 7) is not needed.

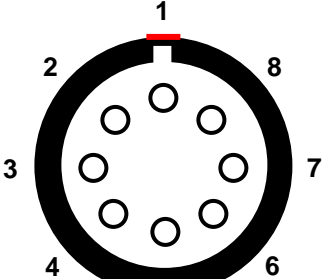
SLICE PRO SIM								
EEG.2B.308.CLL*								
								
(panel view)								
(Suggested cable connector P/N: FGG.2B.308.CLAD52)								
Pin assignments: Option 49**								
1	2	3	4	5	6	7	8	Case
+Ex	-Sig	+Sig	-Ex	-IEPE/Shield	+ID	-ID	+IEPE	Shield

\* This option is only available in 9 channel units.

\*\* Compatible with legacy TDAS option G sensors if external shunt resistors are not installed.



**SLICE PRO SIM**

EEG.1B.307.CLL

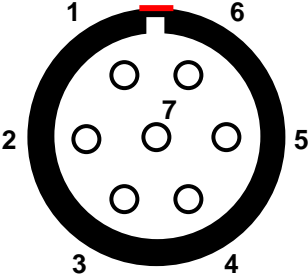

(panel view)

(Suggested cable connector P/N: FGG.1B.307.CLAD42\*)

**Pin assignments: Option 50\***

1	2	3	4	5	6	7	Case
+Ex	+ID	+Sig	-Sig	+IEPE	-Ex	-IEPE/-ID/Shield	Shield

\* Compatible with legacy TDAS option X2 sensors if external shunt resistors are not installed.

**SLICE PRO SIM**

EEG.1B.307.CLL

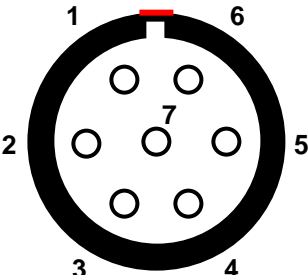

(panel view)

(Suggested cable connector P/N: FGG.1B.307.CLAD42\*)

**Pin assignments: Option 56\*\***

1	2	3	4	5	6	7	Case
+Ex	-Ex	+Sig	-Sig	-IEPE/-ID/Shield	+IEPE	+ID	Shield

\*\* Compatible with legacy TDAS option E3 sensors if external shunt resistors are not installed.

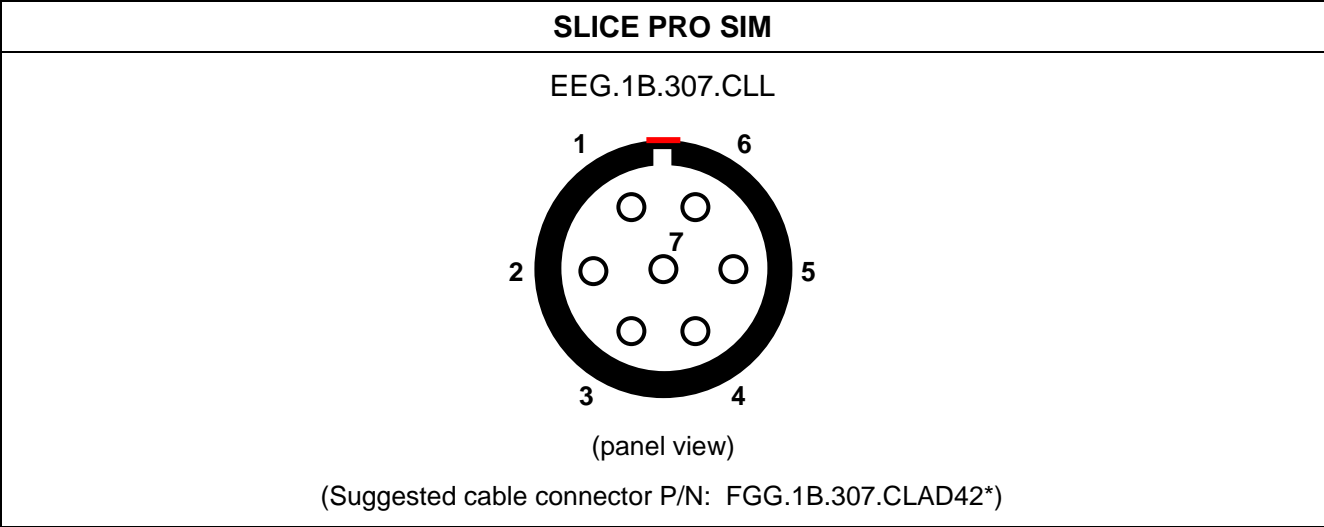

**Pin assignments: Option 60\***

1	2	3	4	5	6	7	Case
+Sig	+Ex	N/C	N/C	-Ex	-Sig	+ID	-ID/Shield

\* IEPE is not supported with this option.

## Appendix B: UP/DOWN Connector Information

**UP interface connector\***  
(Omnetics A99077-015;  
MMDS-015-N06-SS)

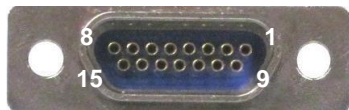

(panel view)

**DOWN interface connector**  
(Omnetics A98000-015;  
MMDP-015-N00-SS)

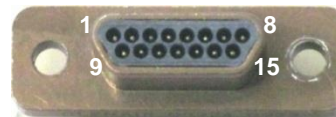

(panel view)

Pin	Function
1	VDC in (UP)/out (DOWN)
2	VDC in (UP)/out (DOWN)
3	Ground
4	Ground
5	/ON (contact closure input to ground)
6	/EVENT (contact closure input to ground)
7	/START (contact closure input to ground)
8	Status input (UP)/output (DOWN) (5 V via 10k with respect to ground)
9	VDC in (UP)/out (DOWN)
10	VDC in (UP)/out (DOWN)
11	Ground
12	Ground
13	USB_DP
14	USB_DM
15	USB power

\* The UP connector may appear loose. Do not tighten.

**25-pin Bus connector**  
(172-025-102R021)

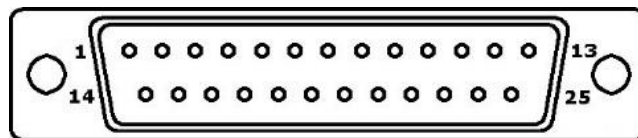

(panel view)

Pin	Function
1	Reserved
2	Reserved
3	No connection
4	USB_DM (UP)
5	USB_DP (UP)
6	USB power (UP)
7	No connection
8	Reserved
9	Reserved
10	VDC in
11	VDC in
12	VDC in
13	VDC in
14	Reserved
15	USB_DM (DOWN)
16	USB_DP (DOWN)
17	USB power (DOWN)
18	Status (5 V via 10k with respect to ground)
19	/START, CC to ground
20	/EVENT, CC to ground
21	/ON, CC to ground
22	Ground
23	Ground
24	Ground
25	Ground

# Appendix C: Mechanical Specifications

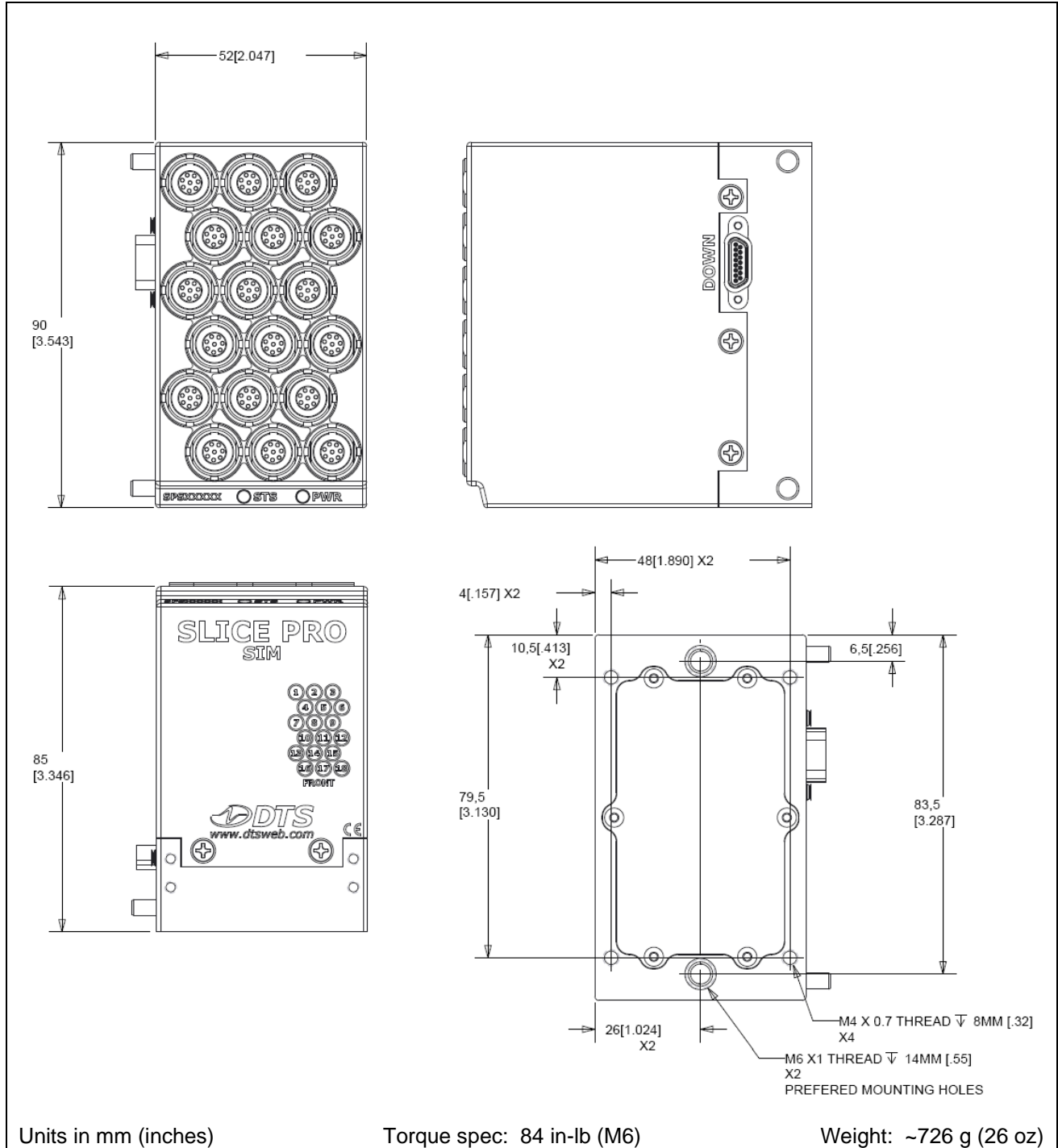

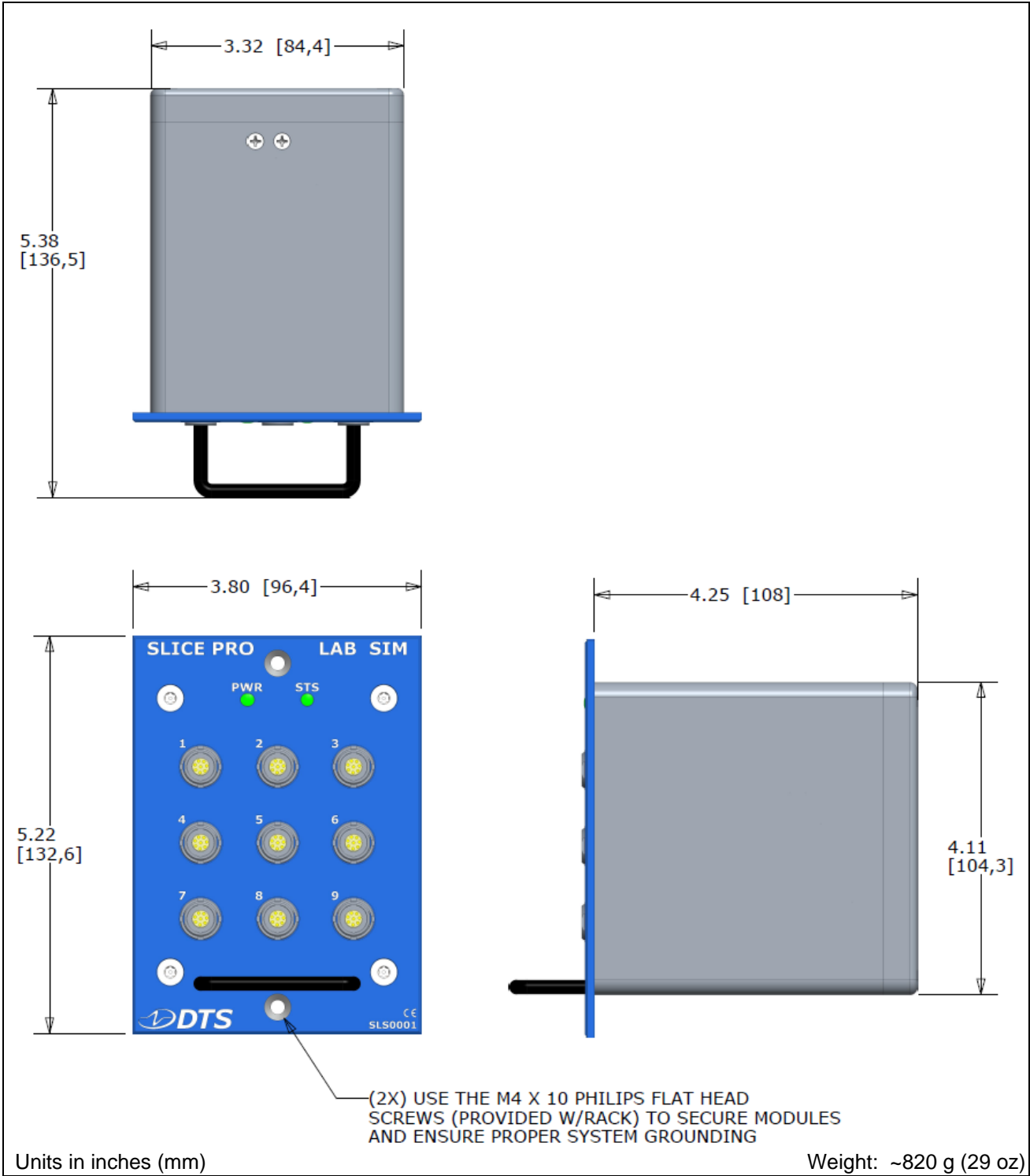

**Accessories/Support Equipment**

- 13000-30603: SLICE PRO USB Controller (micro D)
- 13000-30610: SLICE PRO Ethernet Controller
- 13000-31080: SLICE PRO LAB Rack Benchtop Enclosure (DAS not included)
- 13000-40332: SLICE PRO USB Controller (micro D) and Cable Kit (Gen2.5)
- 13000-40340: SLICE PRO Baseplate Kit for USB Controller + 4 SIMs
- 13000-40350: SLICE PRO Baseplate Kit for USB Controller + 2 SIMs
- 13000-40360: SLICE PRO Baseplate Kit for Ethernet Controller + 4 SIMs
- 13000-40370: SLICE PRO Baseplate Kit for Ethernet Controller + 2 SIMs
- 13000-40380: SLICE PRO Baseplate Kit for USB Controller + 1 SIM
- 13100-00010: SLICE PRO LAB 4-module Rack, Ethernet
- 15010-2xxxx: Cable, Range Expander (20 V)
- 15010-4xxxx: Cable, Range Expander (40 V)
- 15010-6xxxx: Cable, Range Expander (60 V)
- 15010-8xxxx: Cable, Range Expander (800 V)

(xxxx = multiple termination options available)

## Appendix D: How to Calculate Data Storage Duration

The SLICE PRO SIM has user-selectable sampling rates from 100 sps to 1 Msps. The maximum sampling rate for 9 channels is 1 Msps; the maximum sampling rate for 18 channels is 500 ksp. Only 9 channels (channels 1-9 specifically) are available for any sampling rate >500 ksp.

Sampling Rate	9-channel SLICE PRO SIM	18-channel SLICE PRO SIM
100-500,000 sps	9 channels available*	18 channels available*
>500,000-1 Msps		9 channels available*

\* All channels are recorded even if they are not needed for your test.

With 15 GB available for data storage, there are 7,500 M samples available in each SLICE PRO SIM (1 sample = 2 bytes). To determine the recording time possible given the number of channels and sampling rate, use the equation below:

$$\frac{7,500,000,000}{\text{Sampling rate (sps)} \times \text{\# of channels (9 or 18)}} = \text{\# of seconds}$$

Example 1: 100,000 sps using 9 channels

$$\frac{7,500,000,000}{100,000 \times 9} = 8,333 \text{ sec (2.32 hours)}$$

Example 2: 25,000 sps using 18 channels

$$\frac{7,500,000,000}{25,000 \times 18} = 16,667 \text{ sec (4.63 hours)}$$

### Circular Buffer Limitations

Due to the nature of flash memory, the system cannot be armed in *Circular Buffer* mode indefinitely. To determine the maximum time available in *Circular Buffer* mode, use the equation below:

$$0.8 * \text{recording time} = \text{maximum time available in } \textit{Circular Buffer} \text{ mode}$$

Example:

$$0.8 * 8,333 \text{ sec} = 6,666 \text{ sec (111 minutes)}$$

In this example, the test must occur within 111 minutes, after which time the unit stops recording data.





1720 Apollo Court  
Seal Beach, CA 90740 USA  
+1 562 493 0158  
[www.dtsweb.com](http://www.dtsweb.com)

## DECLARATION OF CE CONFORMITY

Description	Model
Data Acquisition Module	SLICE PRO Sensor Input Module
Data Acquisition Module	SLICE PRO Timed Output Module
Data Acquisition Module	SLICE PRO Digital Input Module
Data Acquisition Module	SLICE PRO Trigger Distributor
Data Acquisition Module	SLICE PRO Ethernet Controller
Data Acquisition Module	SLICE PRO USB Controller

The undersigned hereby declares that the products listed above, manufactured by Diversified Technical Systems, Inc., Seal Beach, California, USA, conform to the following directive and standards:

Applicable Council Directive: **89/336/EEC – Electromagnetic Compatibility**

Applicable Harmonized Standards: **EN 55022:1998, EN 55024:1998**

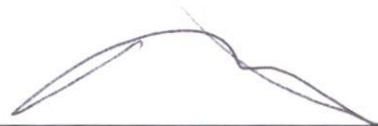
  
\_\_\_\_\_  
Rollin White  
Head of DTS, Senior Director

February 17, 2022  
\_\_\_\_\_  
Date

## Revision History

Rev	Date	By	Description
0	28 Mar 2014	EK	Initial release. Copied 13000-72121-MAN (Rev 1) and revised.
1	13 May 2014	EK	Updated LED tables. Added additional SIM P/Ns to products manual supports.
2	27 Jun 2014	EK	Revised sections DTS Support, Supported Sensor Types, Excitation Sources, Bridge Completion, and Sampling Rates. Removed SLICE PRO SIM Single Channel Block Diagram. Updated Circular Buffer Mode section and Appendix C. Removed specific software references. Other minor updates.
3	7 Oct 2014	EK	Added sensor connector option 44 to Appendix A. Removed "Shield" from pins 5 & 7 for Option 39 (per JP). Updated page 4.
4	24 Oct 2014	EK	Added sensor connector option 45 to Appendix A. Updated page 4.
5	11 Nov 2014	EK	Updated sensor connector option 39 (Appendix A). Pin 5 was -ID; pin 7 was -IEPE.
6	5 Jan 2015	EK	Removed option 44. Added option 46. Updated sensor connector option 39 (Appendix A). Pin 5 was N/C; pin 7 was -IEPE/-ID. Created separate appendix for sensor connector pin assignments (now Appendix A), adding text addressing multiple connections for a single signal and alternate LEMO options.
7	13 Mar 2015	EK	Added sensor connector option 40. Removed voltage value from pins 1, 2, 9 and 10 in Appendix B. Added additional SIM P/N to products manual supports.
8	19 Aug 2015	EK	Corrected appendix references. Added Option E/04 pin assignment and added additional SLICE PRO SIM P/Ns.
9	8 Sept 2015	EK	Added Option 47 pin assignment and additional SLICE PRO SIM P/Ns.
10	13 July 2016	EK	Updated to include SLICE PRO LAB. Revised max VDC input. Added grounding info. Added operational temp range. Added CE Declaration as Appendix E.
11	3 Nov 2016	EK	Added Option 49 and 50 pin assignments. Corrected hardware filter table. Updated LAB option to support 18 channels.
12	5 June 2017	EK	Added Option 41.
13	18 May 2018	EK	Added Option 25.
14	27 Nov 2018	EK	Corrected hardware filter table (page 7).
15	10 Apr 2019	EK	Added Option 09 (H).
16	14 Oct 2019	EK	Added Option 56 (E3).
17	28 Apr 2020	EK	Added additional PWR LED indicator table for new firmware version. Removed LED references in Continuous Recorder Mode section.
18	15 Feb 2022	EK	Added link to sensor connector diagrams (page 6). Removed/updated IEPE references (pages 4 and 6). Corrected $\pm 3$ mV to $\pm 3$ V (Input Range, page 6). Added high and maximum hardware filter footnote (page 7). Replaced 3RT01-R7F with 3RT01-RW7F. Removed reference to Gen3.
19	15 Sept 2022	EK	Added Option 60.