



909 Electric Ave., Suite 206
Seal Beach, CA 90740 USA
Phone: +1 562 493 0158
Fax: +1 562 493 3158
www.dtsweb.com

TSR PRO and TSR PRO-HB User's Manual



March 2013

Table of Contents

| | |
|--|-----------|
| DTS Support | 3 |
| Introducing the TSR PRO and TSR PRO-HB Shock Recorders | 4 |
| Overview of TSR Features | 4 |
| Triaxial Accelerometer..... | 5 |
| Temperature Sensor | 5 |
| DB15F Interface/Communications | 5 |
| Power/Charging Requirements | 5 |
| <i>Using External Power</i> | 6 |
| Status (STS) LED | 6 |
| Using the Event Input and Output | 7 |
| Using the Magnet and Motion Sensor Options..... | 7 |
| Basic Care and Handling | 8 |
| Shock Rating | 9 |
| <i>Mounting Considerations</i> | 9 |
| Thermal Considerations..... | 9 |
| TSR Control 2 Software | 9 |
| Software Installation..... | 9 |
| Communicating with the TSR | 10 |
| Initializing the TSR to Collect Data..... | 11 |
| Downloading Data | 12 |
| Viewing Data | 13 |
| Exporting/Backing-up/Deleting Data | 14 |
| Real Time Mode | 15 |
| Appendix A: Connector Information | 16 |
| External Event Input..... | 17 |
| Appendix B: Mechanical Specifications | 18 |
| Appendix C: Battery Information (for primary TSRs with replaceable batteries) | 19 |
| Battery Sources | 19 |

DTS Support

TSR PRO and TSR PRO-HB shock recorders are designed to be reliable and simple to operate. Should you need assistance, DTS has support engineers worldwide with extensive product knowledge and test experience to help via telephone, e-mail or on-site visits.

The best way to contact a DTS support engineer is to e-mail support@dtsweb.com. Your e-mail is immediately forwarded to all DTS support engineers worldwide and is typically the fastest way to get a response, particularly if you need assistance outside of normal business hours. For assistance by telephone, please go to <http://dtsweb.com/support/techsupport.php> to find the phone number appropriate for your region of the world.

This manual supports the following products:

- 13000-60160: TSR PRO Triax Shock Recorder; 50 g (primary battery)
- 13000-60161: TSR PRO Triax Shock Recorder; 50 g (rechargeable)
- 13000-60162: TSR PRO-HB Triax Shock Recorder; 50 g (rechargeable)
- 13000-60170: TSR PRO Triax Shock Recorder; 250 g (primary battery)
- 13000-60171: TSR PRO Triax Shock Recorder; 250 g (rechargeable)
- 13000-60180: TSR PRO-HB Triax Shock Recorder; 50 g (primary battery)
- 13000-60190: TSR PRO-HB Triax Shock Recorder; 500 g (primary battery)
- 13000-60191: TSR PRO-HB Triax Shock Recorder; 500 g (rechargeable)
- 13000-60210: IDR (Incident Data Recorder); 250 g (primary battery)

Introducing the TSR PRO and TSR PRO-HB Shock Recorders

The TSR PRO and TSR PRO-HB shock recorders are rugged data recorders with an integrated three-axis accelerometer and temperature sensor. The TSR is an ultra-low-power system that permits unattended monitoring of shock and vibration events. When armed, the TSR waits in a ready state to record any event where the specified acceleration threshold is exceeded. It then returns to the ready state to wait for the next event.

Overview of TSR Features

- Rated for 500 g dynamic testing environments.
- Internal, three-axis accelerometer with factory set ranges of ± 50 or ± 250 g (TSR PRO) and ± 50 or ± 500 g (TSR PRO-HB).
- Internal 1 GB flash for >2 hours of data at maximum sampling rate.
- Records internal temperature, date and time for each event.
- 16-bit ADC.
- Both models are available with either an integrated, rechargeable battery (rechargeable) or user-replaceable, non-rechargeable battery (primary).
- Available 6-36 VDC external power input uses internal battery as back-up.
- Programmable level trigger from 2 to 10% of full scale.
- All communication signals and power/battery charging are supported via the DB15F interface.
- Integrated thru holes for mounting.



TSR PRO (primary)
(rechargeable also available)



TSR PRO-HB (rechargeable)
(primary also available)

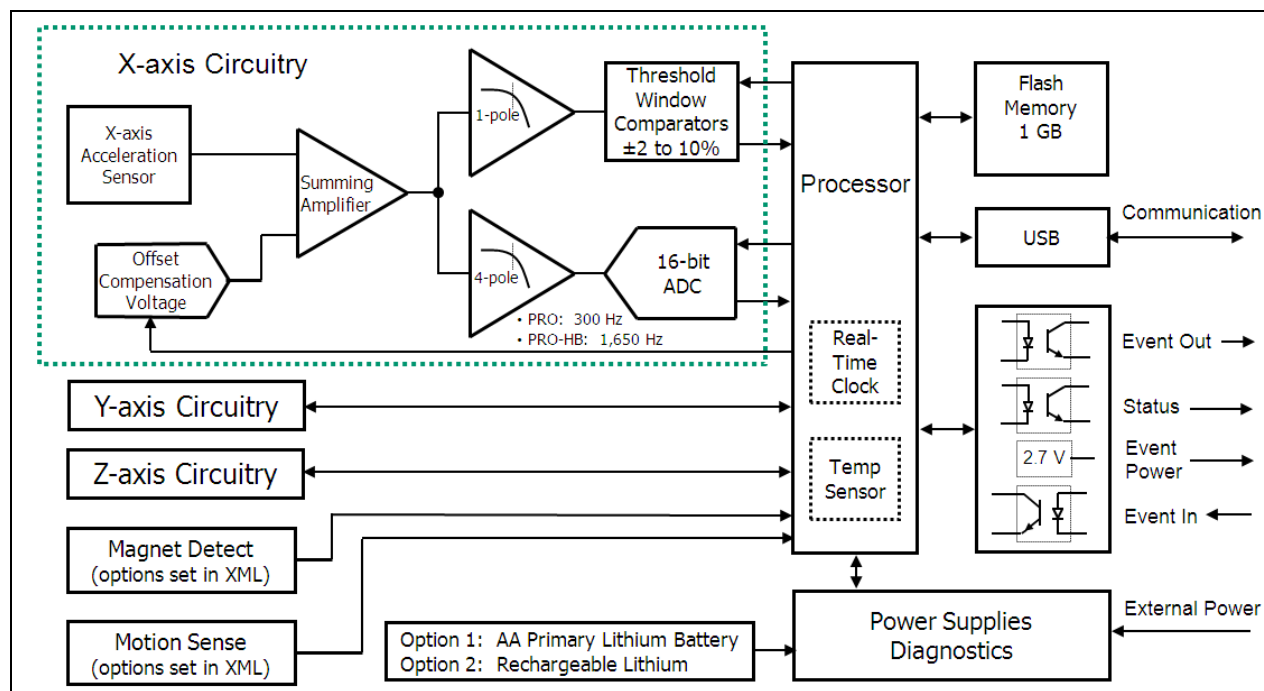

TSR PRO Block Diagram

Triaxial Accelerometer

The TSR PRO and TSR PRO-HB are supplied with an integrated, three-axis, MEMS accelerometer with DC response (300 Hz for TSR PRO; 1650 Hz for TSR PRO-HB). If you are unsure what range your TSR supports, this information is available from within the software via the Diagnostics window.

Temperature Sensor

The TSR PRO and TSR PRO-HB are supplied with an integrated temperature sensor. A single sample temperature measurement is recorded for each event. There are no user-selectable settings for the temperature sensor.



DB15F Interface/Communications



All communication signals, power/battery charging, status output, event input and event output signals are supported via the DB15F interface. A TSR-to-USB communication/power cable (P/N 13000-60130) is provided with your unit. Detailed information on installing the software, initializing the TSR, downloading and viewing data begins on page 9. See Appendix A for connector information and pin assignments.

Power/Charging Requirements

The TSR contains either an integrated, rechargeable battery or a user-replaceable, non-rechargeable battery sufficient to operate the unit for extended periods.

| | Rechargeable Battery | Non-Rechargeable (primary) Battery  |
|---------------------------|--|--|
| Capacity/Type | 900 mAh lithium | 3.6 V, 2400 mAh lithium AA cell |
| Battery life ¹ | 2.5 days - 3 months | 3.1 days - 6 months |
| Replace | N/A. Do not remove the battery. These units are not user-serviceable. | User replaceable with Tadiran TL-5903 ² or similar |
| Charge | Always charges when connected to USB (via AC or DC); ~4.5 hours from complete discharge to full charge. | N/A. These units are not rechargeable. |
| LED |  = battery low ³ |  = battery low |

¹ Depends significantly on operating mode and use conditions.

² Data sheet and MSDS can be found in Appendix C. Alternate sources are also identified.







³ Unit will shut down automatically to prevent overdischarge.

Using External Power

When external power is connected, the internal battery functions as a back-up power source. Should primary power be lost, the back-up battery will support data collection until primary power is restored or until the internal battery discharges completely and the unit shuts down. See Appendix A for connector information and pin assignments.

Status (STS) LED

This LED is green, blue or red and is on, off or blinking.

| | |
|---|---|
|  | USB communication in progress |
|  | Preparing flash memory |
|  | Arming/sensor warm-up |
|  | Impact event; data recording in progress |
|  (0.5 Hz) | An event has been recorded (unit is armed and disconnected from PC) |
|  | Battery low |
|  | Hardware error |

WARNING:

Do not perform any critical tests when the LED indicator is blinking red (battery low).

Using the Event Input and Output

The TSR event schematic is shown below. Detailed information on how to implement the event features are included in Appendix A.

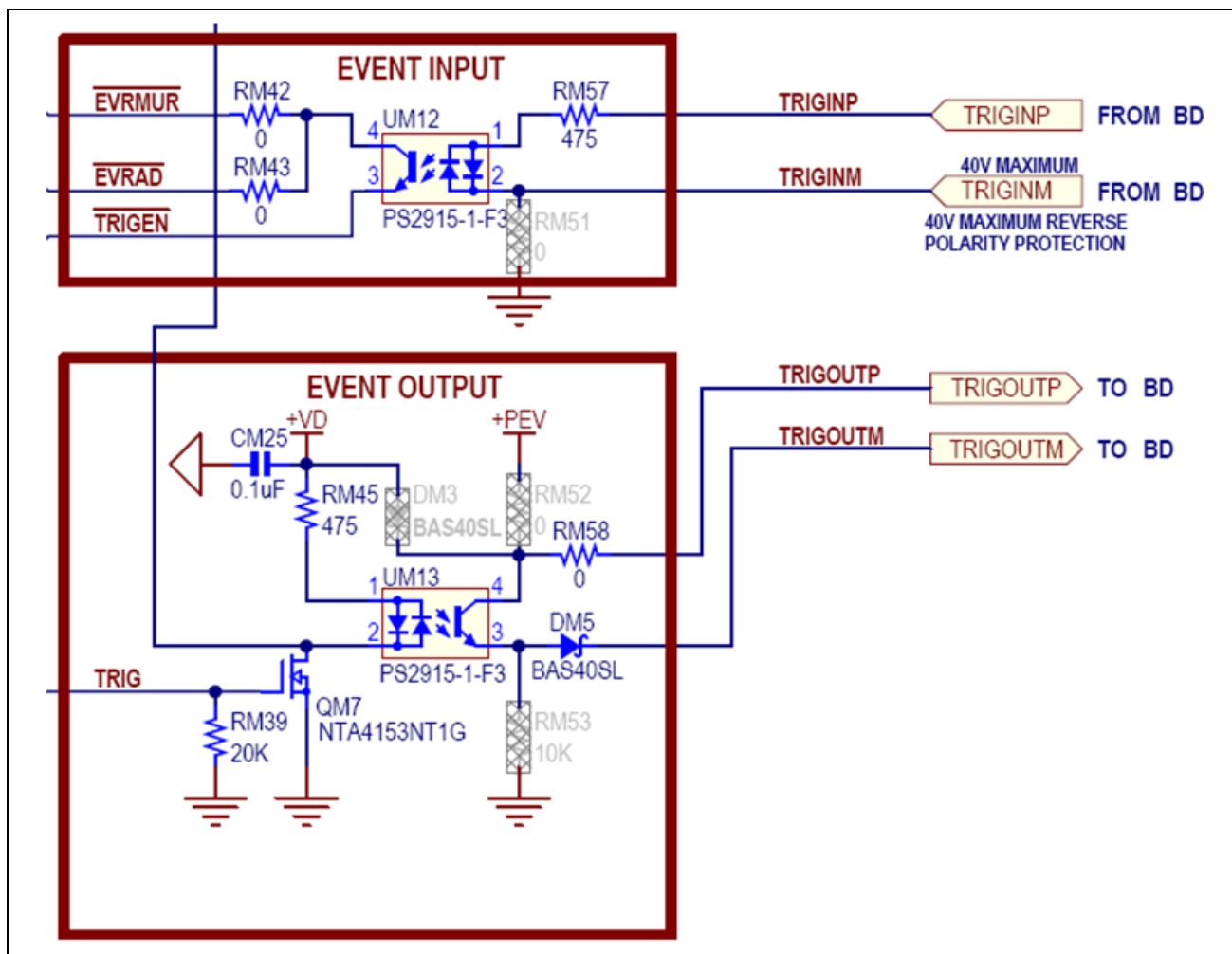

TSR Event Schematic

Using the Magnet and Motion Sensor Options

The TSR includes a magnet sensor and motion sensor to aid in power savings for certain applications.

The magnet sensor can detect the presence of a magnet in close proximity to the TSR. This sensor is used to allow the TSR to go into a deep sleep when the magnet is absent or fully prepare for data acquisition when the magnet is present. When the magnet is

integrated into the TSR mounting scheme, the TSR will automatically prepare itself for data collection when it senses the presence of a magnet. Under most circumstances, the magnet sensor is disabled.

The motion sensor detects very small levels of vibration and motion. If the motion sensor is enabled, whenever the TSR is motionless, it will go into a deep sleep to preserve battery life. When motion is detected, it will wake and prepare itself for data collection. The TSR is normally delivered with the motion sensor disabled. If your application would benefit from the functionality and extended battery life that can be achieved by using the motion sensor, it can be easily enabled, along with a number of time-out parameters.

Control of all magnet and motion sensor options is available through the settings file located in the software directory (e.g., C:\DTS\TSR Control 2\TSRControl2.xml).

```
<MagnetSensorEnable>false<MagnetSensorEnable>  
<MotionSensorEnable>false<MotionSensorEnable>  
where false = disabled (default) or true = enabled
```

Enabling these features will use the default settings for the user-adjustable parameters. There are two user-adjustable parameters for the magnet sensor (<MagnetDetectDelayMilliseconds> and <MagnetRemovalDelayMilliseconds>) and three user-adjustable parameters for the motion sensor (<MotionDetectDelayMilliseconds>, <MotionQualificationPeriodMilliseconds> and <MotionDetectInactivitySeconds>). You may edit these parameters, however you should only do so with full knowledge of the impact to your data.

If you have any questions about using these features, please contact DTS Technical Support for assistance.

Basic Care and Handling

The TSR is a precision device designed to operate reliably in dynamic testing environments. Though resistant to many environmental conditions, care should be taken not to subject the unit to harsh chemicals, submerge it in water, or drop it onto any hard surface.

WARNING:

Electronic equipment dropped from desk height onto a solid floor may experience as much as 10,000 g. Under these conditions, damage to the exterior and/or interior of the unit is likely.

The TSR is supplied with calibration data from the factory. DTS recommends annual recalibration to ensure that the TSR is performing within factory specifications. With

the exception of the user-replaceable (primary) battery, the TSR is not user-serviceable and should be returned to the factory for service or repair.

When not in use or if shipping is required, we suggest that you always place the unit in the padded carrying case originally provided with your unit.

Shock Rating

The TSR is rated for 500 g (survivable to 2,000 g), 1 ms duration, in all axes and can be mounted directly on a vehicle, sled or other dynamic testing device.

Mounting Considerations

The unit should be securely bolted to the test article or dynamic testing device to provide the best shock protection. Mounting methods and hardware selection should be carefully calculated to withstand expected shock loading. (See Appendix B for the TSR's mechanical specifications.)

Thermal Considerations

The TSR is an extremely low power device with negligible self-heating and it is unlikely that self-heating will be an issue in real-world testing. Should you have any questions about using the TSR in your environment, please contact DTS.

TSR Control 2 Software

Software Installation

1. Locate the TSR Control 2 Setup.exe file on the CD or USB drive provided.
Note: If you do not have the TSR Control 2 install file, please contact support@dtsweb.com.
2. Double-click the file to begin the installation and follow the prompts.
Note: For Windows® XP systems, you may be asked to locate the .NET driver. When prompted, you will need to BROWSE to C:\DTS\TSR Control 2\Drivers.

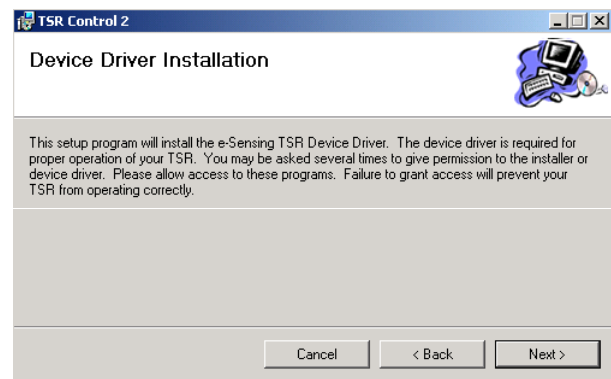

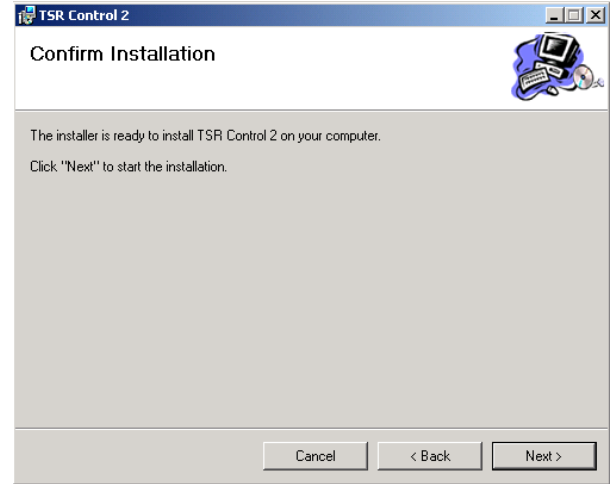
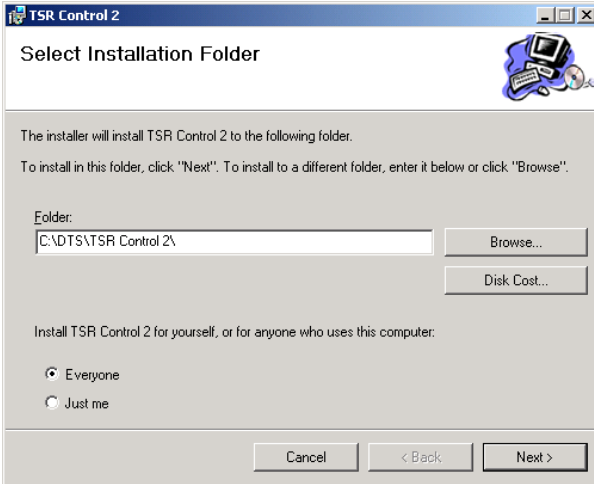

- When you see this screen, installation is complete. Installation will add icons to your desktop, a quick launch toolbar, and TSR Control to your start menu programs.

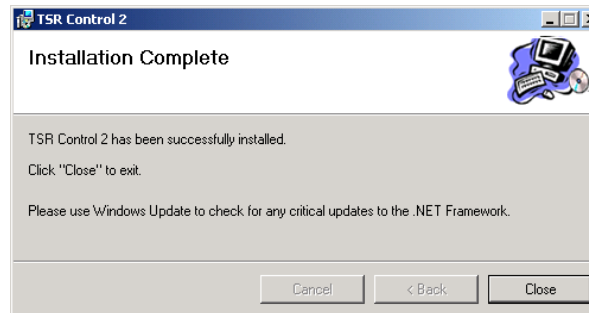

- Start TSR Control by double-clicking the desktop icon or go to C:\DTS\TSR Control 2 and find the TSR Control 2.exe file.

Communicating with the TSR

- Connect the PC to the TSR using the supplied cable. (The TSR can be connected to the PC before or after starting the software.)
- Your screen will look one of two ways, depending on whether the TSR is connected when the software is started.

no TSR connected

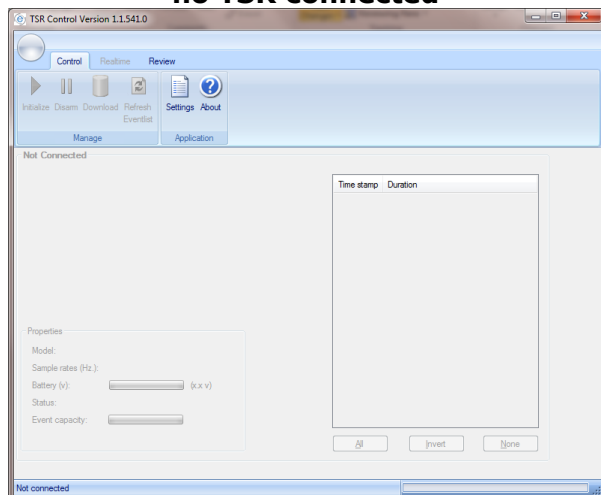

TSR connected

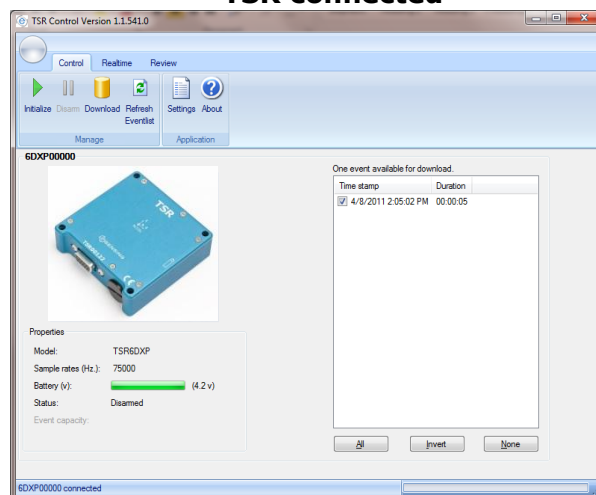

Initializing the TSR to Collect Data

1. Click Initialize  button. Choose the recording time (seconds) and trigger threshold (g) for each channel. For this version of software, the sampling rate is fixed at 10 ksps/channel. (Initializing the TSR synchronizes its timestamp with the PC.)

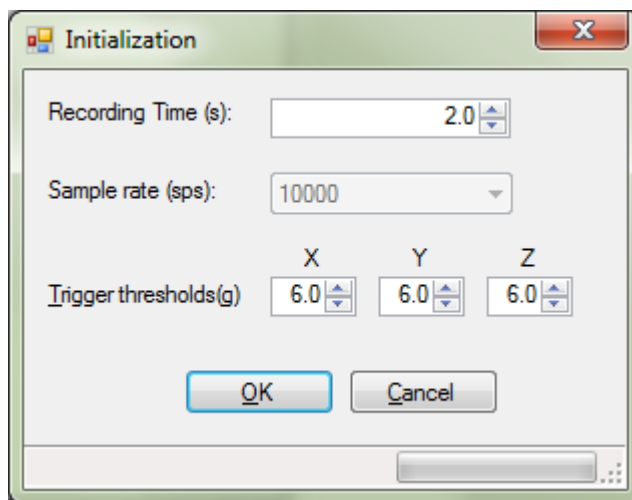

2. After clicking OK, a dialog box will indicate that the system is armed. You can then disconnect the TSR from the PC. The LED will flash blue for ~30 seconds while it is in its arming and sensor warm-up phase. When the LED goes dark, the unit is armed. The TSR will trigger and collect data for the programmed period if the g threshold on any axis is met. The system will automatically re-arm for another event after the previous event recording is complete. (It is not necessary to safely eject hardware.)

Downloading Data

1. Reconnect the TSR to the PC using the supplied cable.
2. The software will ask if you want to disarm the TSR. Click Yes. The TSR must be disarmed before you can download the data.
3. Click the Download button. Depending on the length of the test, it may take several minutes or longer to download the data. A progress bar is shown in the bottom right corner of the screen.
4. You can download multiple events if more than one is stored in the TSR. You can select which events to download or download them all. (Data is available for repeated download until the unit is reinitialized.)

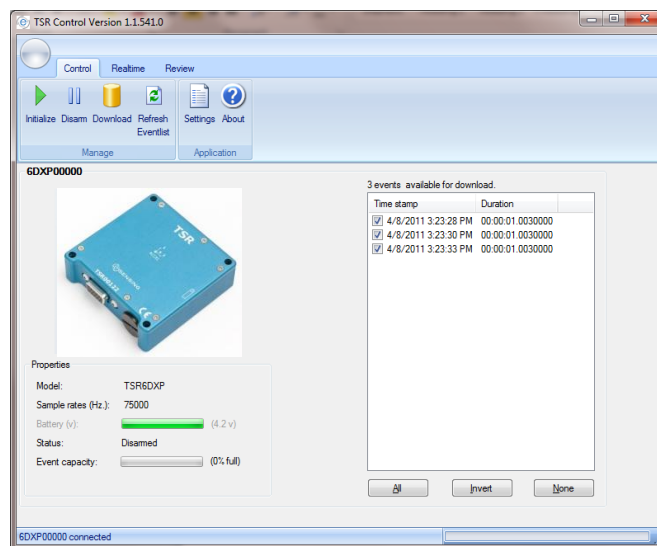

Viewing Data

1. From the screen, click the Review  tab. Available data sets for viewing are shown on the left. These data sets are stored on your PC, not the TSR.

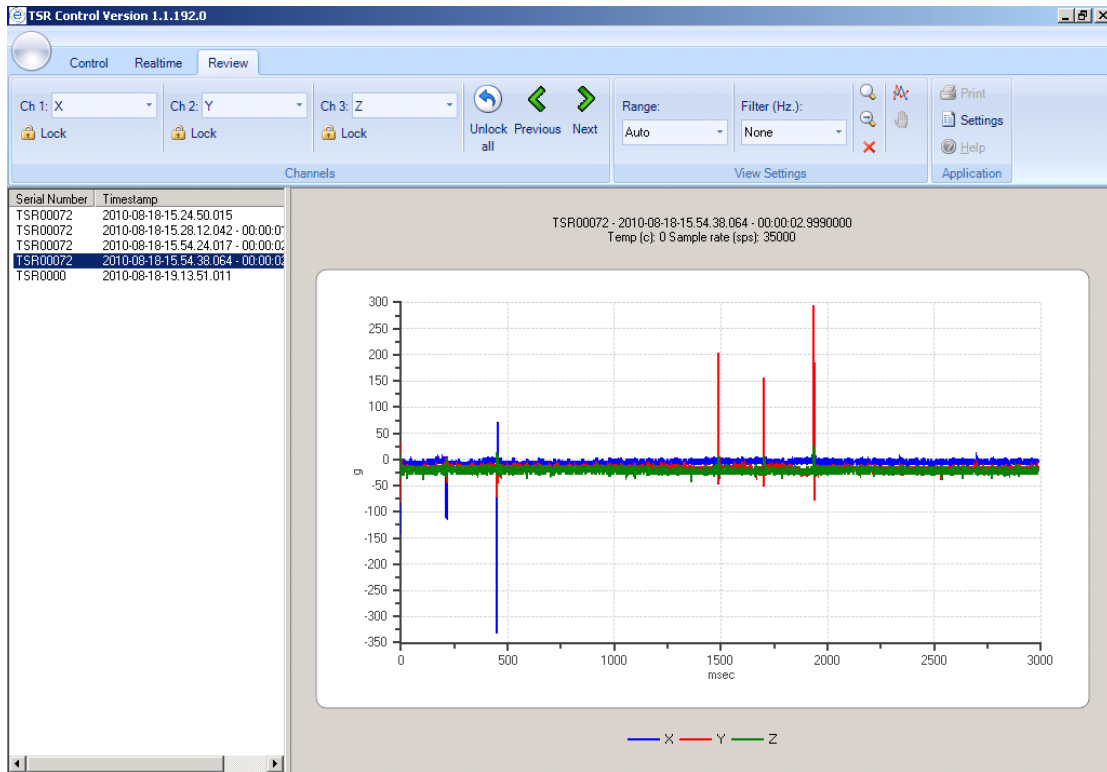

2. To Zoom, you must first select the zoom icon  on the upper right of the screen. You can then use the mouse to draw a window around the data you wish to zoom in on.
3. Three data channels can be viewed on the graph at one time. You can choose which channels to view with the upper left controls.

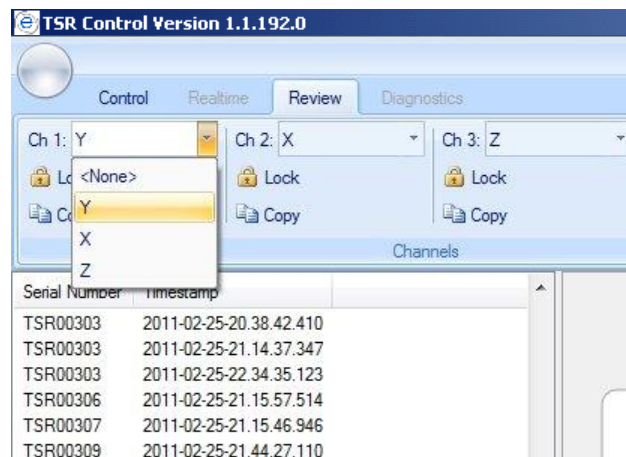

4. The data can be viewed unfiltered or with a -3 dB filter point from the pick list. An FFT on the data can also be performed.

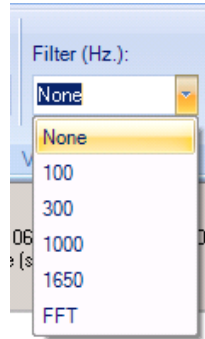

Exporting/Backing-up/Deleting Data

All data is stored in CSV file formats that can be read by Microsoft Excel® or other programs. Data is stored in the C:\DTS\TSR Control 2\Data directory in a subfolder using the serial number of your TSR recorder. The data subfolder contains all data by time stamp. To back-up your data, you can copy this subfolder or you can delete it entirely if you no longer need to keep the data.

Real Time Mode

To view data from the channels real time, click the Realtime tab. You can view any or all of the three channels. Note that the data is being sampled continuously at a relatively low sample rate. For example, you may not see a short duration data pulse when hitting the TSR against a surface.



Appendix A: Connector Information

High density DB15F interface connector

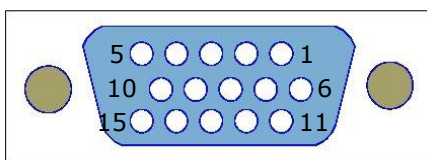

(panel view)

| Pin | Function |
|-----|---|
| 1 | USB Data Positive (to/from PC USB port) |
| 2 | +Status output. Opto-coupler switch closure with respect to pin 12, "-Status Output", (maximum 36 VDC and/or 30 mA) |
| 3 | +Event output. Opto-coupler switch closure with respect to pin 13, "-Event Output", normally open (maximum 36 VDC and/or 30 mA) |
| 4 | +Event input. Opto-coupler input with respect to pin 14, "-Event input". Apply 1.6 to 6.5 VDC to trigger data recording. |
| 5 | Ground |
| 6 | Ground |
| 7 | External power input (+6-36 VDC) |
| 8 | USB PWR (+5 V from PC USB port) |
| 9 | +2.7 V referenced to Ground. May be used as power for Event input, or other uses. |
| 10 | Do Not Connect. Factory use only. |
| 11 | USB Data Minus (to/from PC USB port) |
| 12 | -Status output |
| 13 | -Event output ² |
| 14 | -Event input |
| 15 | Ground |

¹ Most configurations do not support external event power. For more information, please contact DTS Technical Support.

² Event output turns on when either the event input is active or the accelerometer signals are above the threshold.

External Event Input

Using an external event input signal is optional. If you would like to do this, there are two methods available: contact closure or 12 V. The wiring information for each method is shown below.

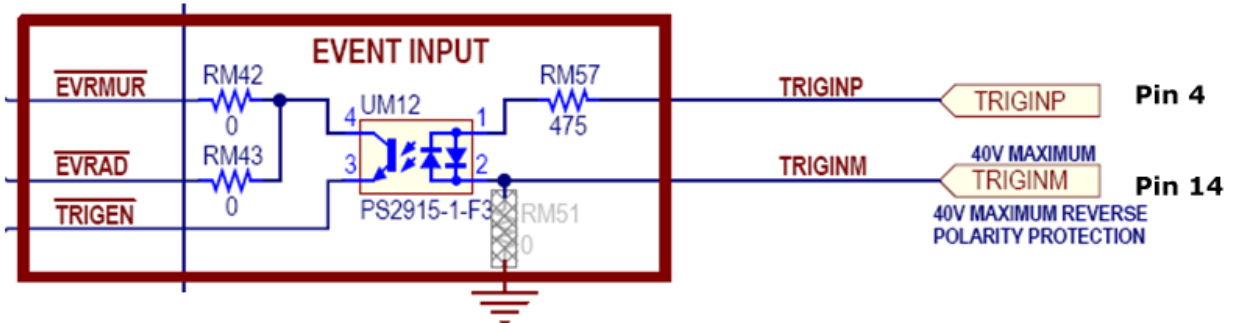

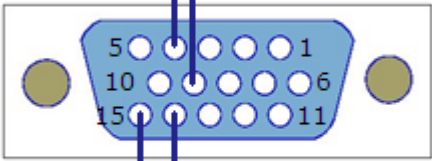
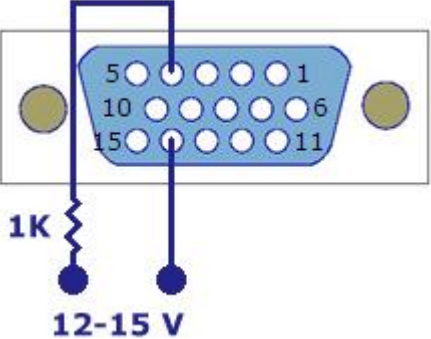
| Contact Closure | 12 V |
|--|--|
| <p data-bbox="300 856 690 892">Jumper pin 4 to pin 9</p>  <p data-bbox="332 1150 690 1186">Switch closure (NO)</p> <p data-bbox="430 1201 592 1234">(panel view)</p> |  <p data-bbox="998 1159 1128 1192">12-15 V</p> <p data-bbox="1079 1201 1242 1234">(panel view)</p> |

Appendix B: Mechanical Specifications

Weight: ~240 g (~8.5 oz)

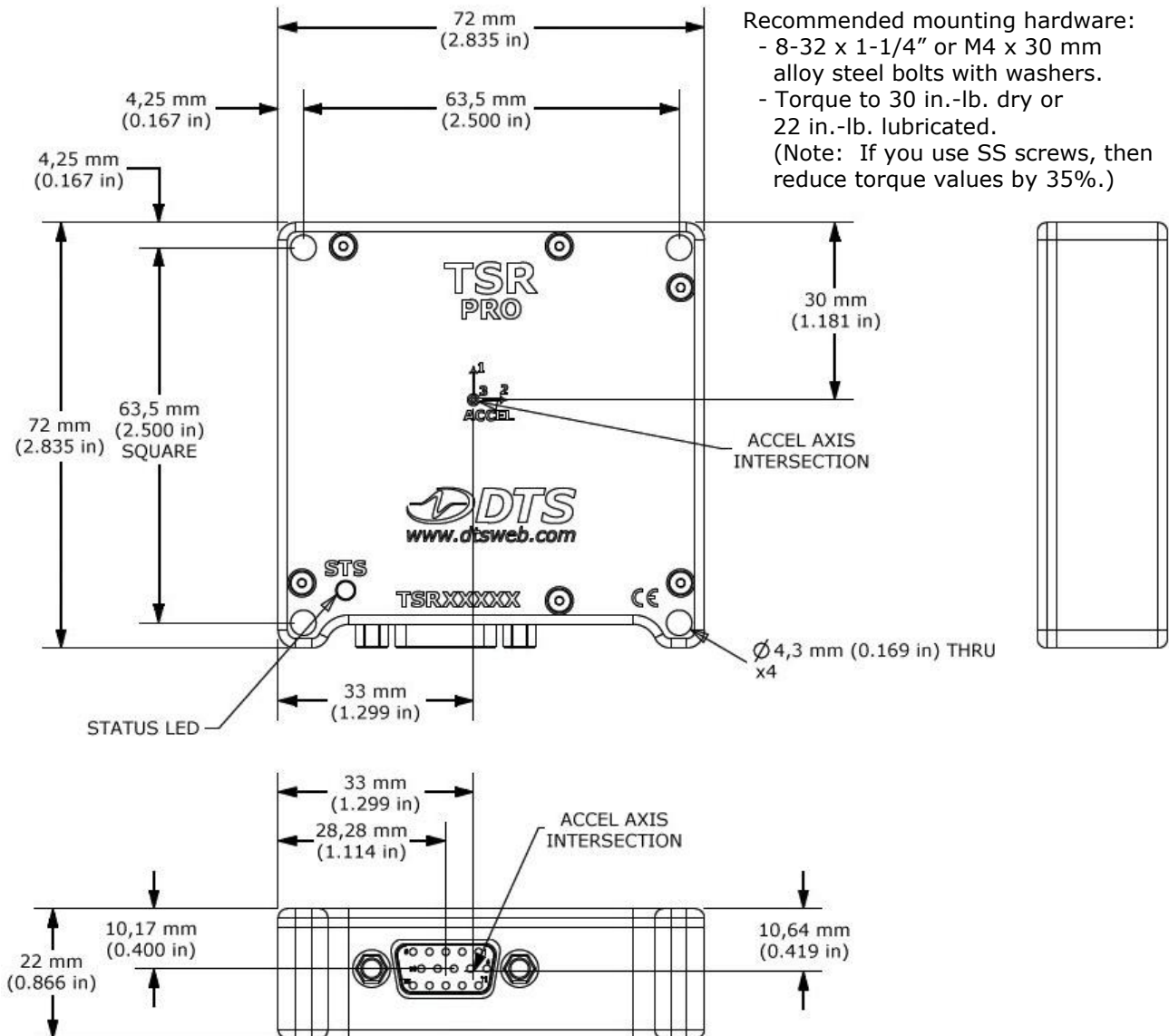

Please contact DTS if you need to purchase additional TSR accessories.

13000-60130: TSR USB Comm Cable (1 m)

24000-00076: TSR Battery Cap (for primary TSRs with replaceable batteries)

99000-00191: Protective cover for DB9F/HD15F connector (black)

Appendix C: Battery Information (for primary TSRs with replaceable batteries)

If your TSR has a removable battery cap (see photo below), then you can replace the battery.



TSR with User-replaceable Battery

If you do not have a removable battery cap, then your TSR includes a rechargeable battery that is not user-serviceable. If you are experiencing problems charging your TSR, contact DTS.

Battery Sources

The data sheet and MSDS for the Tadiran battery are included below. In addition to the Tadiran TL-5903, there are several commercially-available replacement batteries that meet the required specifications. Links to their data sheets are provided below.

Tenergy 30304:

<http://www.all-battery.com/datasheet/Data%20sheet%20Tenergy%2030304%20ER14505.pdf>

Ultralife UHE-ER14505:

<http://ultralifecorporation.com/download/322/>

Revision History

| Date | By | Description |
|-------------|-----|--|
| 20 Mar 2013 | EKK | Replace TSR photos (pg 1, pg 4) with those having DTS logo. Replaced bottom photos on pg 11 and 12. Added new model number (pgs 3, 4). Updated "Magnet and Motion Sensor Options" section. Minor changes to software section. Updated Appendices A, B and C. (Rev 1) |
| 23 May 2011 | EKK | Initial release. (Rev 0) |