



SLICE Free Motion Headform (FMH) User's Manual



January 2018

Table of Contents

DTS Support	3
Introducing the SLICE FMH Headform System	4
Overview of SLICE FMH Headform System	4
<i>Customer Provided: FMH Headform Skin & Skull</i>	4
24000-00341: FMH Upper Neck Integration Kit	5
24000-00355: FMH Headform DAS Kit.....	5
13000-40760: Free Motion Headform (FMH) USB Interface Kit	6
Communications.....	6
Power/Charging Requirements	7
Status LED	8
Basic Care and Handling	9
Shock Rating	9
<i>Mounting Considerations</i>	9
Thermal Considerations.....	9
SLICEWare Software	10
Software Installation.....	10
Communicating with the SLICE FMH Headform System	10
Level Trigger Setup	11
How to Auto-Arm the SLICE FMH Headform System.....	11
<i>Troubleshooting</i>	13
Downloading Data	13
Viewing Data	13
Exporting Data.....	16
Real-Time Mode	17
Appendix A: SLICE Hardware Specifications	18
Appendix B: Pin Assignments	19
13000-30131 Termination Specifications	19
12-pin Interface Connector	19
5-socket FMH Head Interface Connector.....	20
12-socket FMH Head Interface Connector*	20
Appendix C: SLICE FMH Headform DAS Kit Contents	21
Appendix D: SLICE FMH Headform Assembly Procedure	22
Appendix E: Minimizing System Self-Heating	28

DTS Support

SLICE data acquisition systems are designed to be reliable and simple to operate. Should you need assistance, DTS has support engineers worldwide with extensive product knowledge and test experience ready to help via telephone, e-mail or on-site visits.

The best way to contact a DTS support engineer is to submit a request through the DTS Help Center web portal (support.dtsweb.com). You must be registered (support.dtsweb.com/registration) to submit a request (<https://support.dtsweb.com/hc/en-us/requests/new>). Registration also enables access to additional self-help resources and non-public support information.

This manual supports the following products:

- 13000-40760: Free Motion Headform (FMH) USB Interface Kit
- 24000-00341: FMH Upper Neck Integration Kit
- 24000-00355: FMH DAS Interface Kit
- 13000-20100: SLICE NANO Base+ (10-10 cm)

Introducing the SLICE FMH Headform System

The SLICE FMH Headform system is a miniature data acquisition system (DAS) designed for integration into a FMH headform. It includes a battery sufficient to run the system for up to 20 minutes and supports autonomous operation after arming. After the test, reconnecting the system to a PC and the provided power supply allows data download, viewing and post-processing, and recharges the battery for the next use.

Overview of SLICE FMH Headform System

A typical 3-channel system is discussed below. Your system may vary if you have additional channels or custom features.

Detailed information about the SLICE DAS Kit can be found in *Appendix C: SLICE FMH Headform DAS Kit Contents*.

Detailed assembly procedures can be found in *Appendix D: SLICE FMH Headform Assembly Procedure*.

The FMH Headform is integrated with DTS's SLICE NANO Base+, SLICE NANO Bridge, and SLICE NANO FMH Headform Battery. Detailed specifications for the SLICE Base+ and Bridge can be found on page 18 (*Appendix A: SLICE Hardware Specifications*) or at support.dtsweb.com. Details on charging the SLICE NANO FMH Headform Battery can be found on page 7 (*Power/Charging Requirements*). For information on operation of the SLICE system, please see the [SLICE User's Manual](#).

Customer Provided: FMH Headform Skin & Skull

This component is standard on all FMH Headforms.



Figure 1: FMH Headform Skin & Skull (Customer Provided)

24000-00341: FMH Upper Neck Integration Kit

This kit is required for every SLICE FMH. This kit is used to integrate the SLICE Data Acquisition and sensors into the FMH Headform. The replaces the standard FMH / H3 upper neck load cell structural replacement.

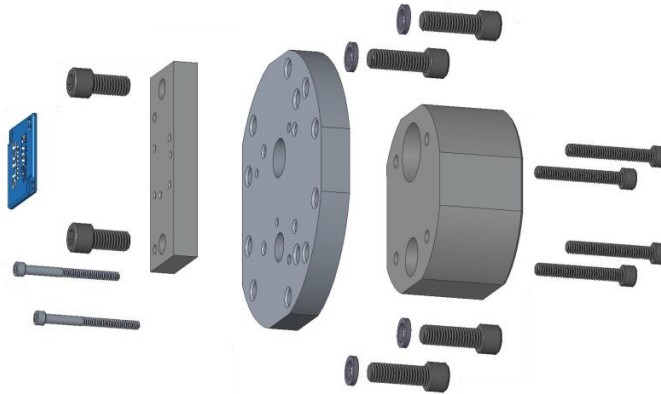

Figure 2: FMH Upper Neck Integration Kit (24000-00341)

24000-00355: FMH Headform DAS Kit

This kit is required for every SLICE FMH. Details of this kit can be found in *Appendix C: SLICE FMH Headform DAS Kit Contents*.



Figure 3: FMH Headform DAS Kit (24000-00355)

13000-40760: Free Motion Headform (FMH) USB Interface Kit

This Free Motion Headform (FMH) USB Interface Kit connects the USB port on your PC and a power supply provided with your system to the FMH Headform via the upper neck structural replacement connector. The SLICE USB Interface connects the FMH Headform SLICE system to a PC via USB. It also powers the SLICE system and charges the on-board battery. A 12 V, 2.5 A power supply is provided with your system. It will simultaneously charge the battery and power the SLICE FMH Headform system until it is disconnected prior to the test. Battery capacity and charging requirements can be found on page 7 (*Power/Charging Requirements*).



Figure 4: Cable and Headform Interface



Figure 5: Power Supply and SLICE USB Interface

Communications

A USB-to-PC communication and power cable is provided with your system. All communication signals and power/battery charging are supported via the LEMO interface. Information on installing the software, initializing the system, downloading and viewing the data begins on page 10 (*Power/Charging Requirements*).

Power/Charging Requirements



The SLICE NANO FMH Headform Battery contains an integrated, 8.4 V, 80 mAh, rechargeable lithium battery sufficient to operate the system for cable-free testing. When the 12 V, 2.5 A power supply is connected to your system, it will simultaneously charge the battery and power the SLICE FMH Headform system until it is disconnected prior to the test.







Battery life (fully charged)	Up to 20 minutes (full sensor load)
Charge time	~1 hour from complete discharge to full charge; always charges when connected to power supply

Charging the system using a maximum of 12 V and without the USB connected minimizes system self-heating. Additional details can be found in *Appendix E: Minimizing System Self-Heating*.

Status LED

This LED is green and provides information on arming and recording status. It is on, off or blinking.

 Blinking	After unit is turned on, LED will blink during sensor warm-up and system arming.
 ON	If armed in Circular Buffer mode, the LED will begin recording after sensor warm-up and the LED will go solid green. The LED will also go solid green in Recorder mode if the system received a START signal.
 OFF	If armed in Recorder Mode, the system will stop blinking and go OFF, waiting for a START signal to begin recording.

Circular Buffer Mode	Recorder Mode
 (rate increases) Arming; sensor warm-up (~30 sec)	
 (LED is ON) System is recording 	 (LED is OFF) Waiting for START signal 
 (rate steady) If the LED continues to blink after 45 sec, the system did not initialize properly. See page 13 (<i>Troubleshooting</i>).	

To arm the system, press and hold the push button switch for ≥ 3 sec. After 7 sec, the LED will begin to blink, indicating the system is performing the auto-arm initialization sequence. After 32 seconds, the LED will be either on (Circular Buffer mode) or off (Recorder mode). *Note: The SLICE FMH Headform system's auto-arm feature must be software-enabled prior to pushbutton initialization. Only Circular Buffer mode is*

recommended for use with the FMH Headform. Details on software installation and use begin on page 10 (*SLICEWare Software*).

Basic Care and Handling

The SLICE FMH Headform is a high precision measurement system designed to operate reliably in dynamic testing environments. Though resistant to many environmental conditions, care should be taken not to subject the unit to harsh chemicals, submerge it in water, or use it in a manner inconsistent with its intended purpose.

The SLICE NANO Base, Bridge and FMH Headform Battery are supplied with calibration data from the factory. DTS recommends annual recalibration to ensure that the system is performing within factory specifications. SLICE hardware is not user-serviceable and should be returned to DTS for service or repair.

Shock Rating

The SLICE FMH Headform system is rated for 500 g, 4 ms duration, in all axes. All mounting considerations should be thoroughly addressed to ensure the system is adequately integrated to survive the expected shock loads.

Mounting Considerations

To provide the best shock protection, the system should be securely bolted inside the FMH Headform skull using the proper hardware and recommended torque specifications. Care must be taken to restrain the cables to permit adequate strain relief and minimal movement upon impact.

Thermal Considerations

SLICE NANO DAS is an extremely low power system with negligible self-heating. Should any self-heating be a concern, this can be addressed by charging the system properly and minimizing the time it takes to arm the system and perform the test (see *Appendix E: Minimizing System Self-Heating*). Should you have any questions about using SLICE in your environment, please contact DTS.

SLICEWare Software

Software Installation

1. Locate the set-up.exe file on the CD or USB drive provided. Double-click the file to begin the installation and follow the prompts on your screen.
2. When installation is complete, copy the XML file found in the folder "*copy contents to SLICEWare directory after software install*" to the SLICEWare directory. (The XML file contains the sensor information.) If you were not provided an XML file, you will have to enter this information later.
3. Start SLICEWare by double-clicking the desktop icon or go to Programs/SLICEWare.

If you have any questions about software installation, please contact [DTS Support](mailto:Support@DTSweb.com). For a detailed software manual, please see support.dtsweb.com.

Communicating with the SLICE FMH Headform System

4. Connect cable to the LEMO receptacle on the backplate (Figure 4). Next, connect the cable to the power supply provided (Figure 5) and your PC. (The SLICE FMH Headform system can be connected to the PC before or after starting the software.)
5. If you provided your own sensors or had to replace a sensor, you can manually enter the sensor information into the SLICEWare software before using your SLICE FMH Headform system. (Check that the sensors that are installed in the FMH Headform are visible on the **Prepare** tab. If any sensor is missing, you need to manually install it.) You will need the calibration data provided with your sensors to do this. Each sensor must also be assigned to the correct axis and optional ISO code.

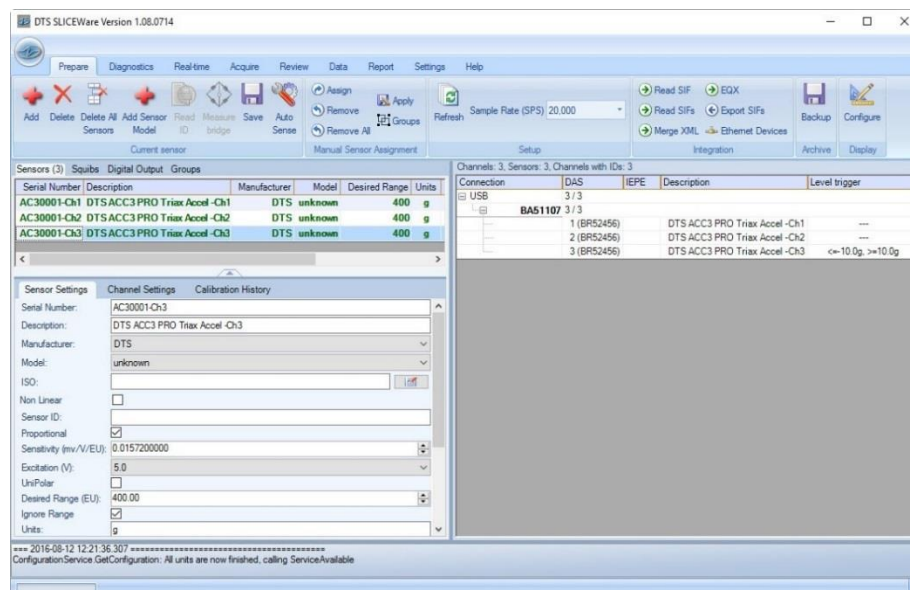

Level Trigger Setup

The SLICE FMH Headform system works best when a "level trigger" is set on one or multiple channels. This will trigger the system and record data when the sensors see g-levels outside of a specified range.

- With SLICEWare running and the SLICE FMH Headform system connected (step 4 above), select the sensor you want to use for level trigger.

Channels: 3, Sensors: 3, Channels with IDs: 3				
Connection	DAS	IEPE	Description	Level trigger
[-] USB	3 / 3			
[-] BA51107	3 / 3			
[]	1 (BR52456)		DTS ACC3 PRO Triax Accel -Ch1	---
[]	2 (BR52456)		DTS ACC3 PRO Triax Accel -Ch2	---
[]	3 (BR52456)		DTS ACC3 PRO Triax Accel -Ch3	<=-10.0g, >=10.0g

- Select the checkboxes and Enter the desired level trigger. Choose a g-value that that is well under your expected test value but not too low that handling or a small bump will trigger the system. Click the Apply button when finished.



How to Auto-Arm the SLICE FMH Headform System

The "Auto-Arm on Boot" feature allows users to automatically arm the system using user-selected parameters at system power-up/initialization. To use the auto-arm feature, all DAS in the test must support the auto-arm function.

- With SLICEWare running and the SLICE FMH Headform system connected (step 4 above), go to the **Diagnostics** tab and perform a quick check to verify the hardware is working properly.

Note: You will see a red box if your battery voltage is too low. The system should be charged for up to an hour before you start your test.

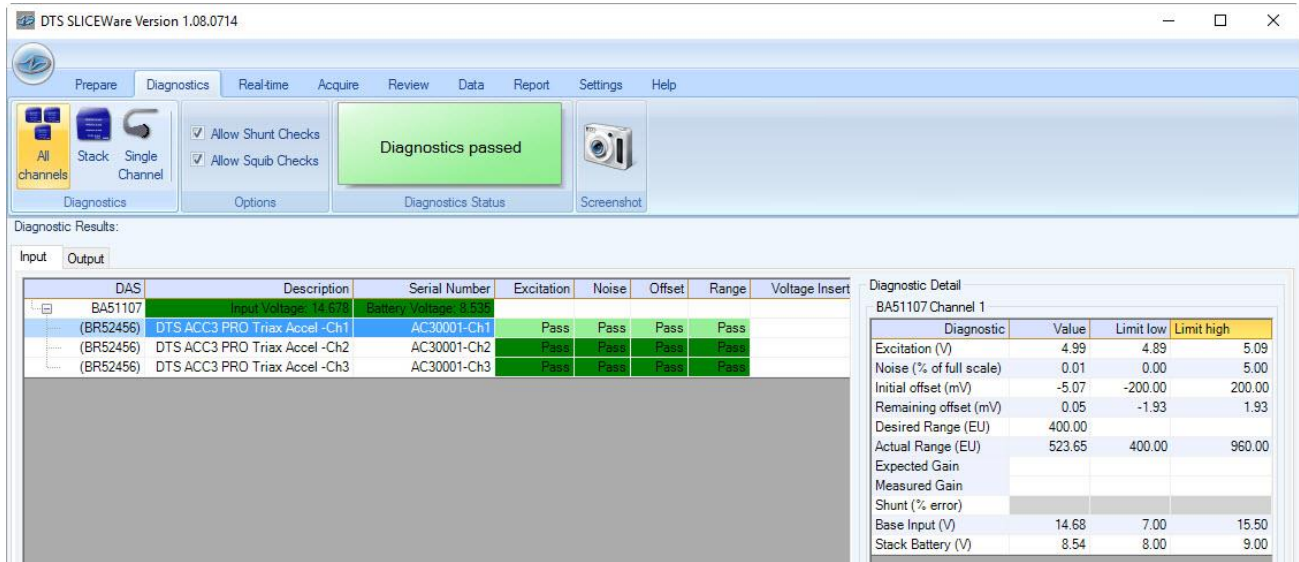

- Open the **Acquire** tab. Complete the test set-up information (data collection mode, length of time, sample rate, etc.).

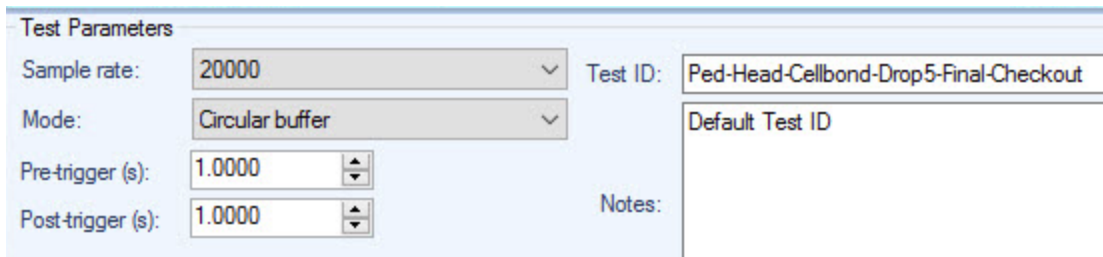

- Click the Auto-Arm button. Click OK.

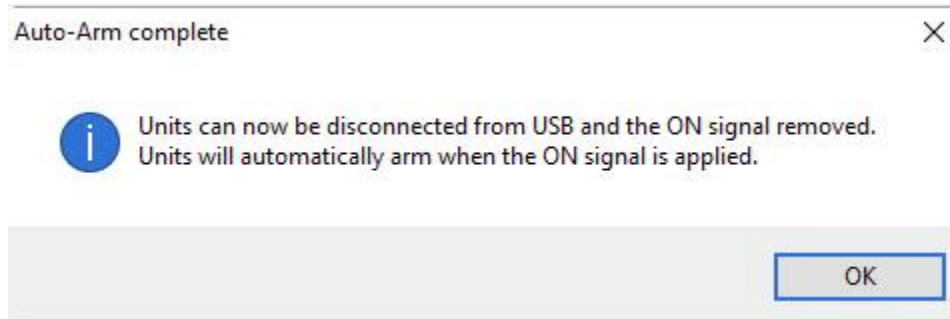

- Close SLICEWare and disconnect cable from the backplate.
- To arm the system, press and hold the LED/pushbutton switch for >3 sec. After 7 sec, the LED will begin to blink, indicating the system is performing the auto-arm initialization sequence. After 32 sec, the LED will be either on (Circular Buffer mode) or off (Recorder mode).

Troubleshooting

If the LED continues to blink after 45 sec, the system did not initialize properly. To clear the fault, reconnect the system to the power supply and PC (step 4 above), then start SLICEWare. Manually arm and test the SLICE FMH Headform system to clear the fault. (You must clear the fault before the system will power down.) After clearing the fault, repeat steps 8-12 above.

Downloading Data

1. Reconnect the system to the power supply and PC (step 4 above). Start SLICEWare.

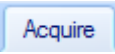
2. Open the  tab. To download the total time specified by the initial test set-

up, select . To download a region-of-interest only, enter the desired

timeframe (for example,

ROI Begin Time (sec)	-0.5
ROI End Time (sec)	0.5

) and then select .

3. Depending on the length of the test, it may take several minutes or longer to download the data. A download progress bar is shown in the center of the screen alongside the corresponding DAS.

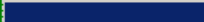
Status				
DAS	Status	Triggered?	Fault?	Data download progress
BA50448	Downloading	No		

Viewing Data

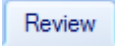
1. Open the  tab. Available data sets for viewing are shown on the left. These data sets are stored on your PC, not the SLICE DAS.

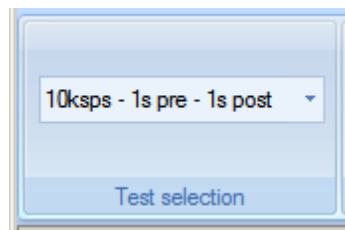

2. Selecting a test will load it in the viewing area.

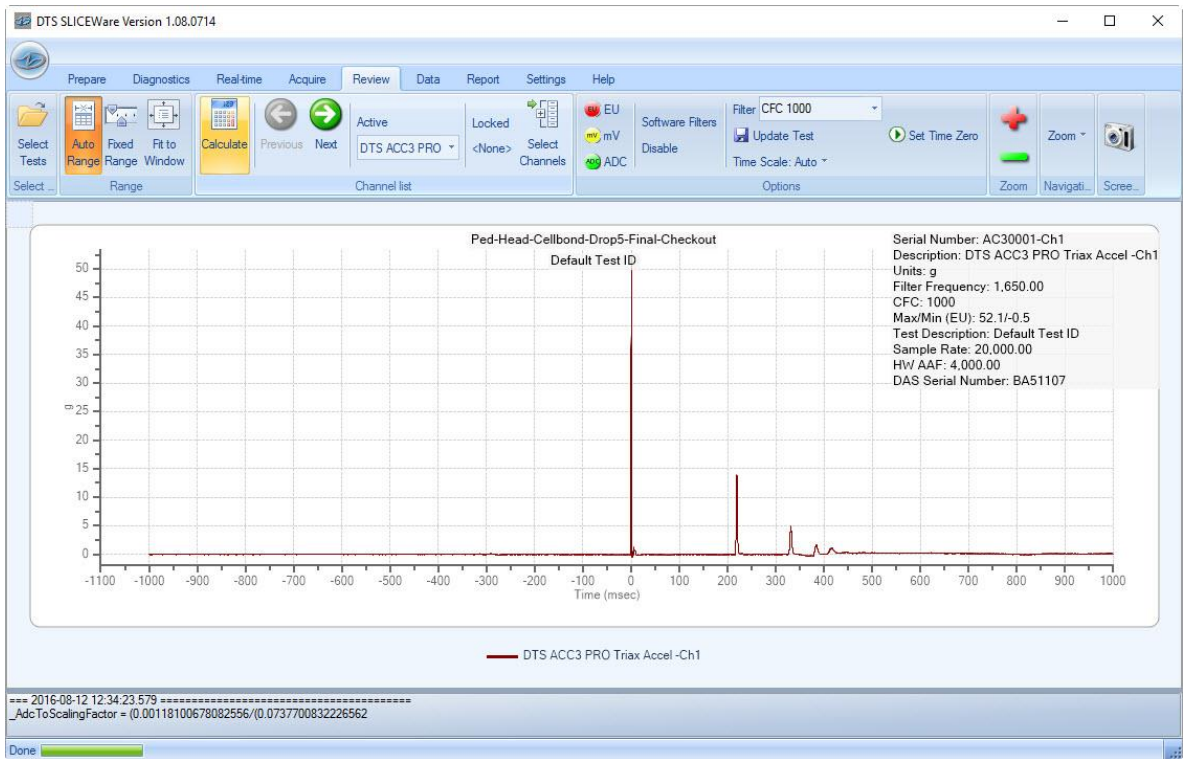

3. To calculate the resultant, Select the Calculate button. Select "Resultant" from the type drop-down list, give this new calculated channel a name, and add the three accelerometer channels. Lastly, select the bottom "Add" button.

Add calculated channel ✕

Type: Resultant ▼

Name: Ped-Head-Resultant-Final-Checkout

Channels: DTS ACC3 PRO Triax Accel -Ch3 Add

DTS ACC3 PRO Triax Accel -Ch1

DTS ACC3 PRO Triax Accel -Ch2

DTS ACC3 PRO Triax Accel -Ch3

Clear

4. Multiple data channels can be viewed on the graph at one time. You can choose

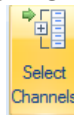

which channels to view using

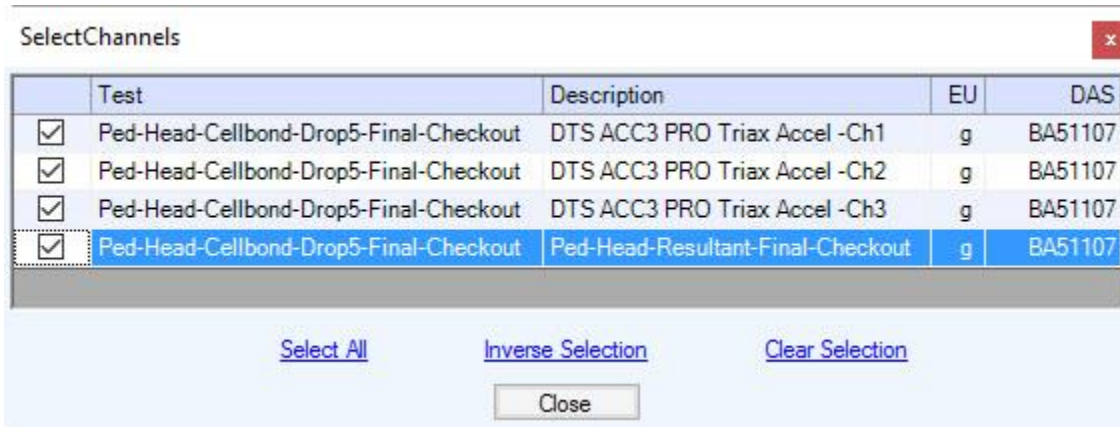

5. You can zoom by drawing a window around a region-of-interest.

6. The data can be viewed unfiltered or using a selected filter.



Exporting Data

1. Open the  tab and select the data set you wish to export from the tests available.

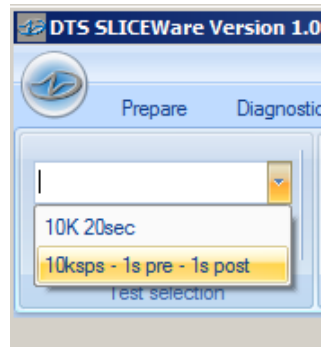

2. Select an export format for the data.

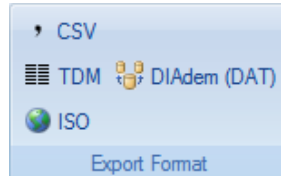

3. Select whether the exported data should be filtered or unfiltered. If filtered is selected, SLICEWare will apply the software filter associated with each sensor in the test.

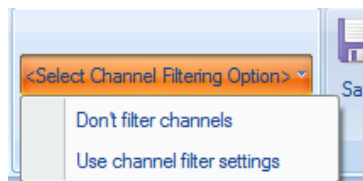

4. To export the data using the settings you selected above, select . A 'save as' dialog will open and allow you to choose where to save the exported data.

Real-Time Mode

To view data from the channels real-time, click the Real-time tab. You can view individual channels, all three channels. Note that the data is being sampled continuously at a relatively low sample rate. For example, you may not see a short duration data pulse when hitting the SLICE against a surface.

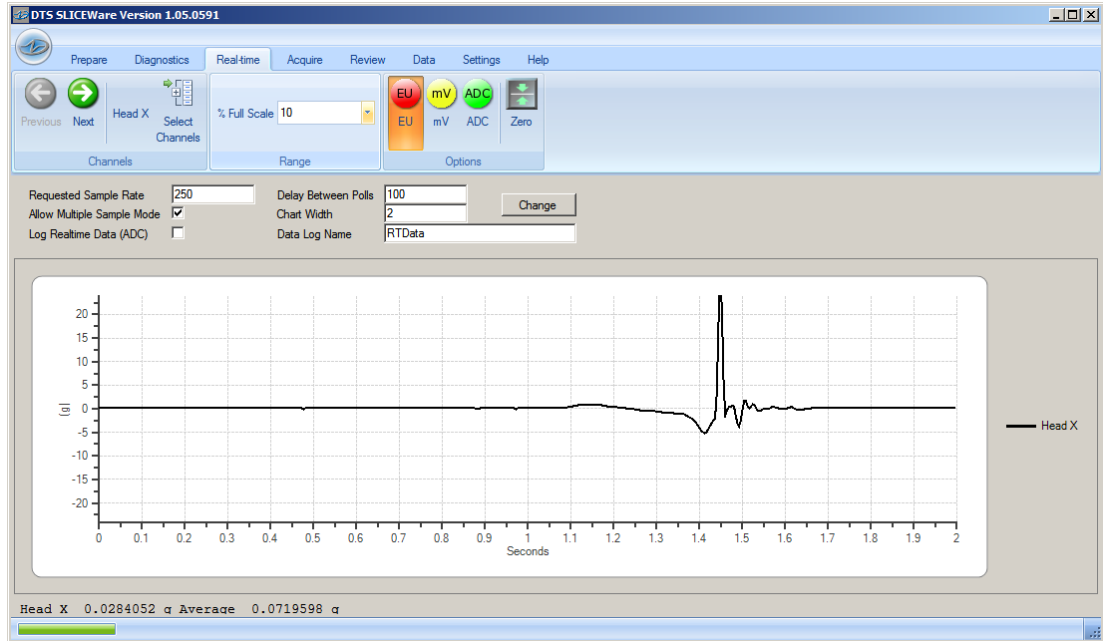

Appendix A: SLICE Hardware Specifications

The details below outline the basic specifications of the SLICE system. The SLICE FMH Headform System uses SLICE NANO.

Specifications



BASE+ SLICE (NANO & MICRO)	
One (1) required per stack – system microprocessor & memory	
Size:	MICRO 42 x 42 x 8 mm (1.65 x 1.65 x 0.32") NANO 26 x 31 x 6.5 mm (1.02 x 1.22 x 0.26")
Mass:	MICRO 28 g (0.99 oz), NANO 14.2 g (0.50 oz)
Connectors:	Omnetics, circular locking, 12-pin MICRO integrated, NANO cable assembly
Compatibility:	BASE+ works with all legacy NANO & MICRO
ENVIRONMENTAL	
Military Standard:	MIL-STD-810E
Operating Temp:	-40° to 60°C (-40° to 140°F) (Method 501,502)
Altitude:	-40°C @ 15240 m (50000 ft) (Method 500)
Vibration (Random):	Exceeds 810-E vibration (Method 514)
Humidity:	95% RH non-condensing
Shock:	500 g, 4 msec half sine 5000 g option (SLICE NANO only)
DATA RECORDING	
Modes:	Recorder, circular buffer, multiple event, arm on power-up, and other modes available
Memory:	16 GB non-volatile flash per SLICE stack
Sample Rate:	Minimum 10 sps per channel
<See Chart for Max:	Up to 200k sps on ≤24 channels per stack Up to 500k sps on ≤3 channels per stack
TRIGGERING	
Hardware Trigger:	Contact closure & TTL logic-level (active low)
Level Trigger:	Positive and/or negative level on any active sensor channel (first level crossing of any programmed sensor triggers system)
POWER	
Supply Voltage:	9-15 VDC; >11 VDC when using Battery SLICE (NANO)
Current (Maximum):	70 mA @ 12 V plus sensor input SLICES
Power Control:	Remote power control input for on/off
Protection:	Reverse current, ESD
SOFTWARE	
Control:	SLICEWare, DataPRO, API
Operating Systems:	Windows® Vista/7/8 (32/64-bit)
Communication:	USB; Ethernet available via SLICE Distributor

BRIDGE SLICE (NANO & MICRO)	
Three (3) inputs for external sensors	
Size:	MICRO 42 x 42 x 7 mm (1.65 x 1.65 x 0.32") NANO 26 x 31 x 5.5 mm (1.02 x 1.22 x 0.22")
Mass:	MICRO 25 g (0.88 oz), NANO 13.8 g (0.49 oz)
Connectors:	Omnetics, circular locking; 3 single-channel 7-pin or 1 three-channel 16-pin
SIGNAL CONDITIONING	
Number of Channels:	3 differential, programmable
Input Range:	±2.4 V (2.5 V center)
Bandwidth:	DC to 40 kHz, programmable
Gain Range:	1.0-1280, programmable
Auto Offset Range:	100% of effective input range
Bridge Support:	Software controlled half-bridge completion
Shunt Check:	Emulation method, automatically calculated
Sensor ID:	Maxim Integrated (Dallas) silicon serial number
Linearity (typical):	≤0.2% (gain 1 to 320), ≤0.5% (gain >320)
Accuracy:	0.5% including reference uncertainty
ANALOG-TO-DIGITAL CONVERSION	
Type:	16-bit SAR (Successive Approximation Register) ADC, one per channel, simultaneous sample of all channels.
EXCITATION	
Method:	Independent regulator for each channel
Voltage:	5.0 V, up to 20 mA, short circuit safe
Power Management:	Shutdown when not armed or recording
POWER	
Voltage:	Supplied via BASE SLICE
Current (Maximum):	110 mA with 350 ohm bridges all channels Power varies significantly with sensor load
ANTI-ALIAS FILTER	
Fixed Low Pass:	4-pole Butterworth, standard knee frequency at 40 kHz
Adjustable Low Pass:	5-pole Butterworth set by software from 1 Hz to 40 kHz
Response:	Meets SAE J211/ISO6487 response corridors

Appendix B: Pin Assignments

13000-30131 Termination Specifications



(looking into the connector)

Pin	Wire color	Function	Notes
1	Green	+Sig	
2	White	-Sig	
3	Red	+Ex	
4	Yellow	+ID	
5	Black	-Ex	
6	Shield	-ID/Shield	Solder bridge on pins 6 and 7

12-pin Interface Connector (LEMO ECG.2B.312.CLL)

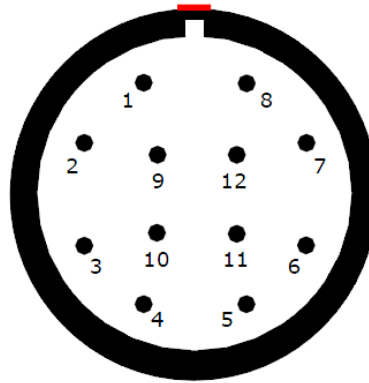

(panel view)

Pin	Function
1	/ON
2	/START
3	/EVENT
4	Status
5	12-15 VDC IN
6	12-15 VDC IN

Pin	Function
7	Ground
8	Ground
9	USB power
10	USB_DP
11	USB_DM
12	Ground

5-socket FMH Head Interface Connector

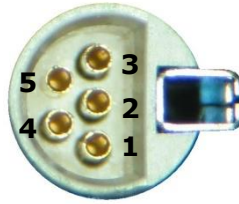

(looking into the connector)

Pin	Function
1	$\overline{\text{Status}}$
2	Ground
3	+Status
4	$\overline{\text{On}}$
5	Event

12-socket FMH Head Interface Connector*

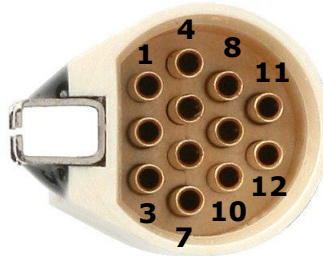

(looking into the connector)

Pin	Function
1	$\overline{\text{On}}$ (contact closure input to ground)
2	$\overline{\text{Start}}$ (contact closure input to ground)
3	$\overline{\text{Event}}$ (contact closure input to ground)
4	Status output (5 V via 10K with respect to ground)
5	12–15 VDC
6	12–15 VDC
7	Ground
8	Ground
9	USB_PWR
10	USB_DP
11	USB_DM
12	Ground

* These connectors are identical.

Appendix C: SLICE FMH Headform DAS Kit Contents



Figure 6: SLICE FMH Headform DAS Kit

13000-30701: Cable, SLICE FMH PC Comm Interface

13000-30681: Cable, SLICE FMH LED Pushbutton

13000-20090: SLICE FMH Stack Battery

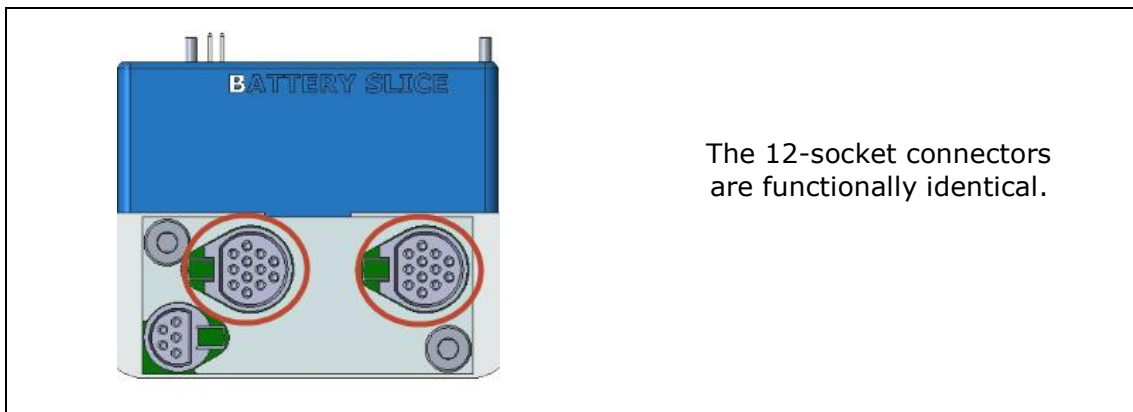

Figure 7: FMH Headform Interface

Appendix D: SLICE FMH Headform Assembly Procedure

Note: If Loctite is called out in this procedure, use a small amount of *Loctite 222MS Low Strength*. Use standard bolt torques unless specifically called out for in these procedures.

1. Install Connector Cable Assembly: Install Lemo connector in the structural replacement body. Adjust the back nut so the connector face does not protrude past the structural replacement face. Use a standard Lemo nut tightening tool. Note the orientation of the connector key.



3. Install Switch LED Assembly: Carefully insert the Switch LED connector of the Switch LED Assembly through the hole. The Switch LED will audibly snap into place with a small amount of force.

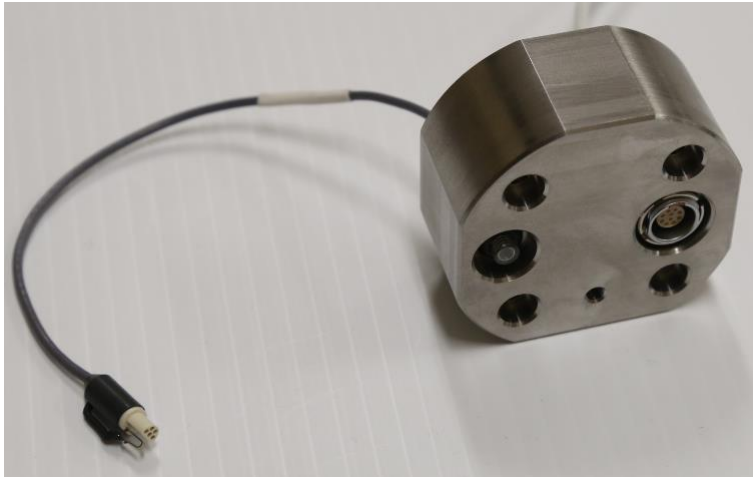
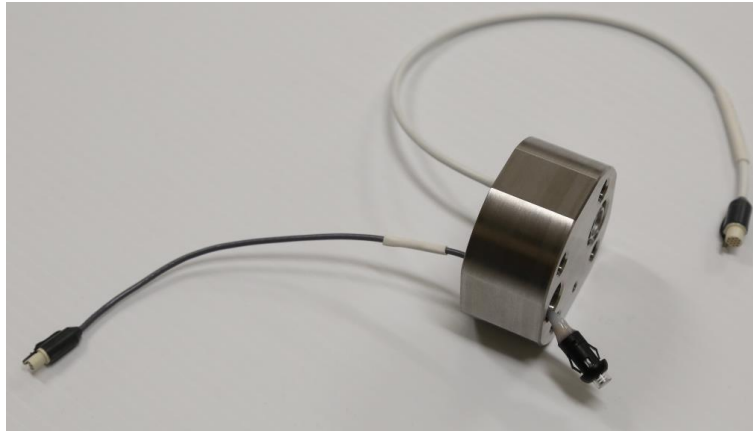

4. Install Structural Replacement Plate: Apply Loctite to 4X 8-32 x 1-1/8" SHCS Screws and install through main body into plate. Note orientation of the plate to the body.

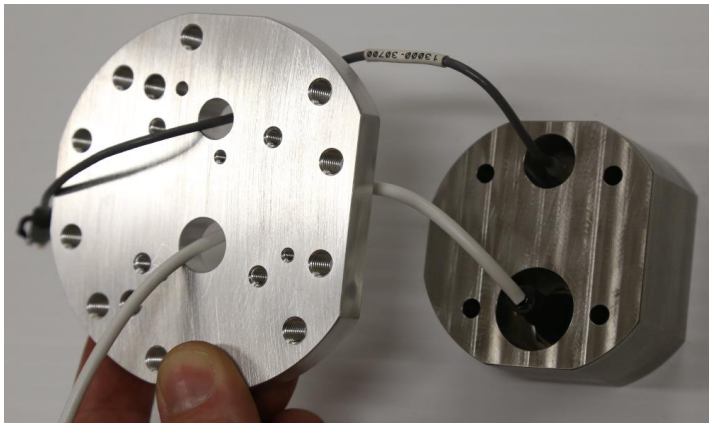

5. Install Sensor Mount: Use 2X ¼-28 x 1/2" Alloy Steel Socket Cap Screws to secure sensor mount to plate. Install the proper accelerometer mount depending on the type of sensor used. The 7264 style accelerometer mount is shown below.

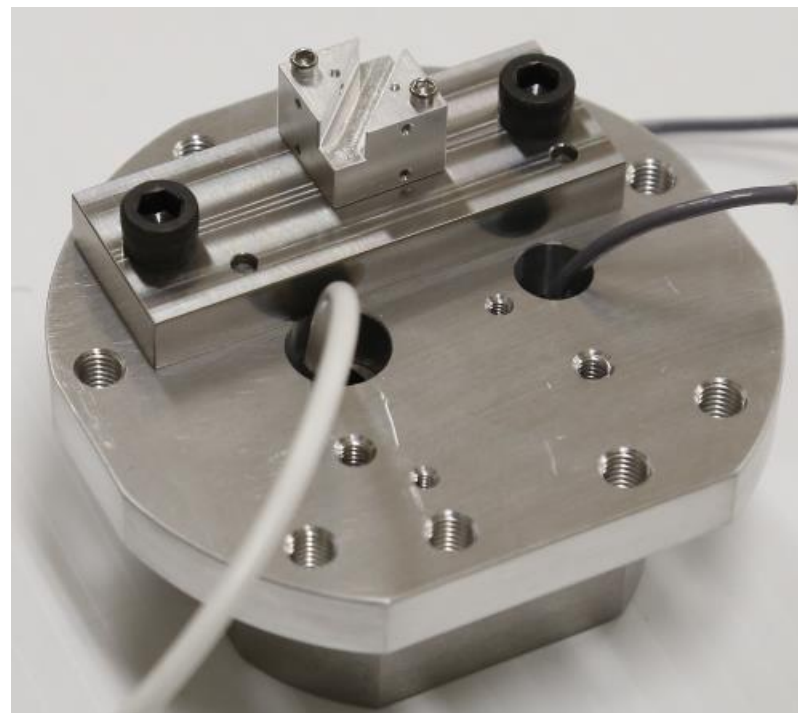
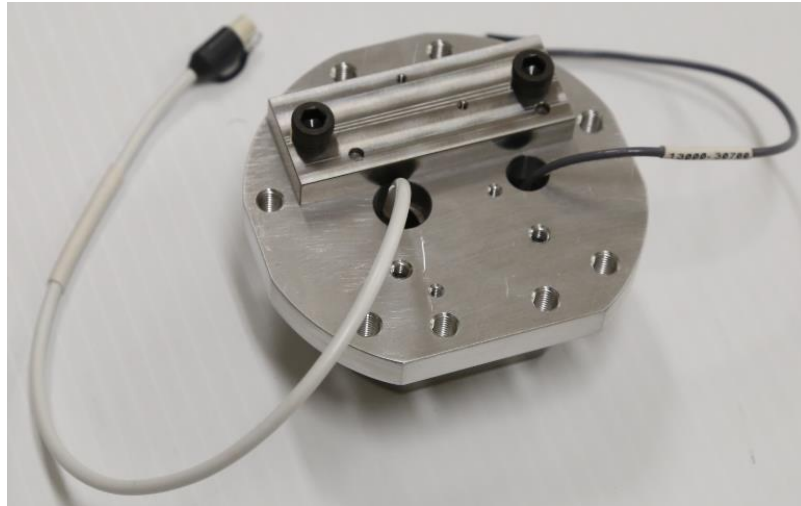

6. SLICE Stack Assembly: First, plug the SLICE NANO Bridge to the top of the SLICE NANO Base. Next, carefully plug the SLICE NANO FMH Headform Battery to the bottom of the SLICE NANO Base. Lastly, add the SLICE Stack Cover and install 2X M3 x XX mm Stainless Steel Socket Head Cap Screws. Use a very light coat of Loctite on the last few threads.

Note: Your SLICE NANO Bridge could have one or three connectors depending on the type of accelerometers requested.

WARNING:

The power pins on the battery are **LIVE** and the battery could be damaged if the pins touch any metal, including the bottom of the SLICE NANO Base metal enclosure.

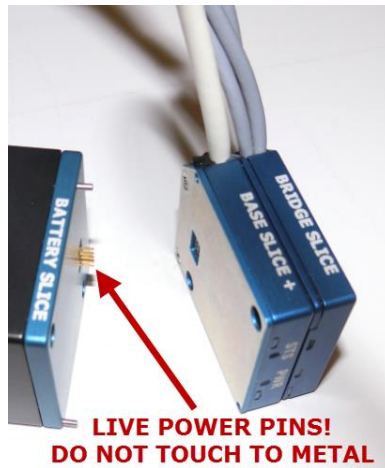

1. DAS and Sensor Mounting: Mount accelerometers or 6DX PRO or ACC3 PRO to manufacturer's instructions and torque. When using the DTS ACC3 PRO or 6DX PRO sensors, do not forget to use the included spacer (89100-19440) to bring the sensor to the correct height.

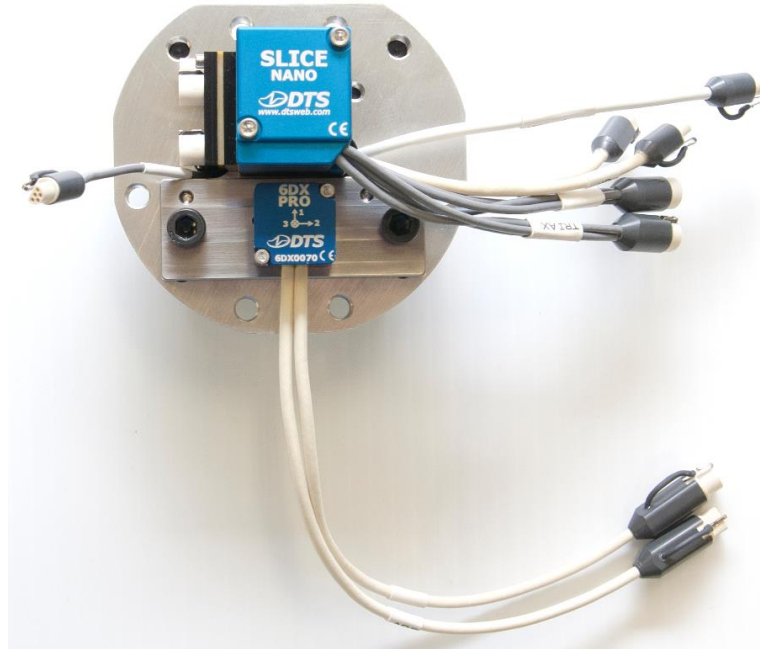

2. Strain Relief Cables: Connect two 12-pin and one 5-pin connector as shown. Note: The two 12-pin connectors are functionally identical and can be plugged into either side. Use the provided Cable Ties to tie down and strain relief all cables. The picture below provides example using DTS 6DX PRO sensor.



3. Install Skull and Skin Assembly: Insert the SLICE FMH neck assembly into the headform by rotating 90 degrees once inside the skull. Install all fasteners.



4. Assembly Complete!

Appendix E: Minimizing System Self-Heating

Follow the procedure outlined below to avoid any unnecessary heat generation in excess of $\sim 1^{\circ}\text{C}$.

1. Charge the system using a 12 V power supply. 12 V is the minimum required by the SLICE system; anything in excess will contribute to heat generation.

2. Do not connect your PC to the system while it is charging. While this prevents checking system status, continual PC communications keep the microprocessor active. If the battery is not completely discharged and you do not want to wait the maximum recharge time (1 hour), you may wish to implement a hardware interface that allows you to check battery charge status. When the input current drops to 75 mA, the battery is fully charged.

3. Complete the software auto-arm sequence and disconnect the system from the PC and power supply within 2 minutes. Completing this step quickly minimizes system and sensor self-heating. Once auto-arm and disconnect are completed, the system is in a low-power state and awaiting initialization.

4. Initialize the system and perform your test quickly. To initialize the system, press the LED/pushbutton switch for ≥ 3 sec. When the LED goes solid, the system is ready for testing. Performing your test as soon as possible after system initialization minimizes self-heating.

Revision History

Rev	Date	By	Description
0	22 Jan 2019	GSN	Initial release.